



INSTALLATION INSTRUCTIONS

3INCH SIDEBAR

2019-2023 SILVERADO/SIERRA 1500 CREW CAB (Excluding Body Lift Kit)

2020-2024 SILVERADO/SIERRA 2500/3500 CREW CAB (Body Mount)

PART# 3S-19C1062N

TAC
TRUCK ACCESSORIES COMPANY

PARTS LIST:

1	Driver/Left Sidebar	16	8mm x 30mm Hex Bolts
1	Passenger/Right Sidebar	16	8mm Lock Washers
8	Mounting Brackets	16	8mm x 24mm OD x 2mm Flat Washers
16	8mmx 25mm Combo Bolts		

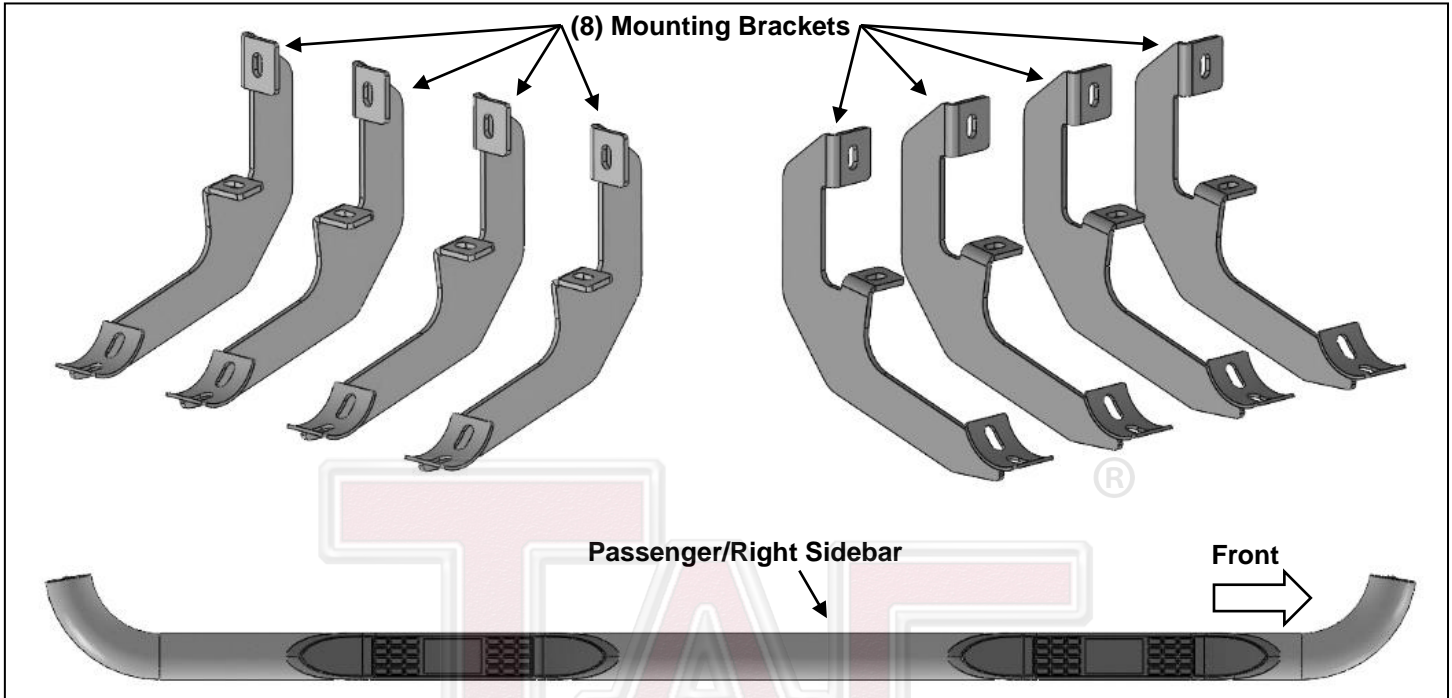

PROCEDURE:

REMOVE CONTENTS FROM BOX. VERIFY ALL PARTS ARE PRESENT. READ INSTRUCTIONS CAREFULLY BEFORE STARTING INSTALLATION. ASSISTANCE IS RECOMMENDED.

1. Start the installation under the Passenger/Right side of the vehicle.
 - a. For “Early” 2019 models, locate the 6 plugs along the bottom edge of the body. Mounting Brackets will bolt to the 1st, 3rd, 4th and 6th threaded mounting holes, **(Figure 1)**.
 - b. For “Late” 2019 models, all (4) mounting locations will be used.
2. Remove the plastic plugs from the Passenger/Right front mounting location. Select (1) Mounting Bracket. Attach the Mounting Bracket to the factory threaded holes with (2) 8mm Hex Bolts, (2) 8mm Lock Washers and (2) 8mm Flat Washers, **(Figures 2 & 3)**. Do not tighten hardware at this time.
3. Repeat **Steps 1 & 2** to attach the 2nd, 3rd and Rear Mounting Brackets along the rocker panel, **(Figures 4—7)**. Do not tighten hardware at this time.
4. Select the Passenger/Right Sidebar. Carefully place Sidebar on the brackets. **IMPORTANT:** Do not slide or rotate Sidebar on cradles, or damage to the finish may result. Attach Sidebar to the Mounting Brackets with (8) 8mm Combo Bolts, **(Figure 8)**. Do not tighten hardware at this time.
5. Level and adjust the Sidebar and fully tighten all hardware.
6. Repeat **Steps 1—5** to attach the Driver/Left Sidebar.
7. Do periodic inspections to the installation to make sure that all hardware is secure and tight.

To protect your investment, Do not use any type of polish or wax that may contain abrasives that could damage the finish. Mild soap may be used also to clean the Sidebar.

Passenger/Right side Installation Pictured

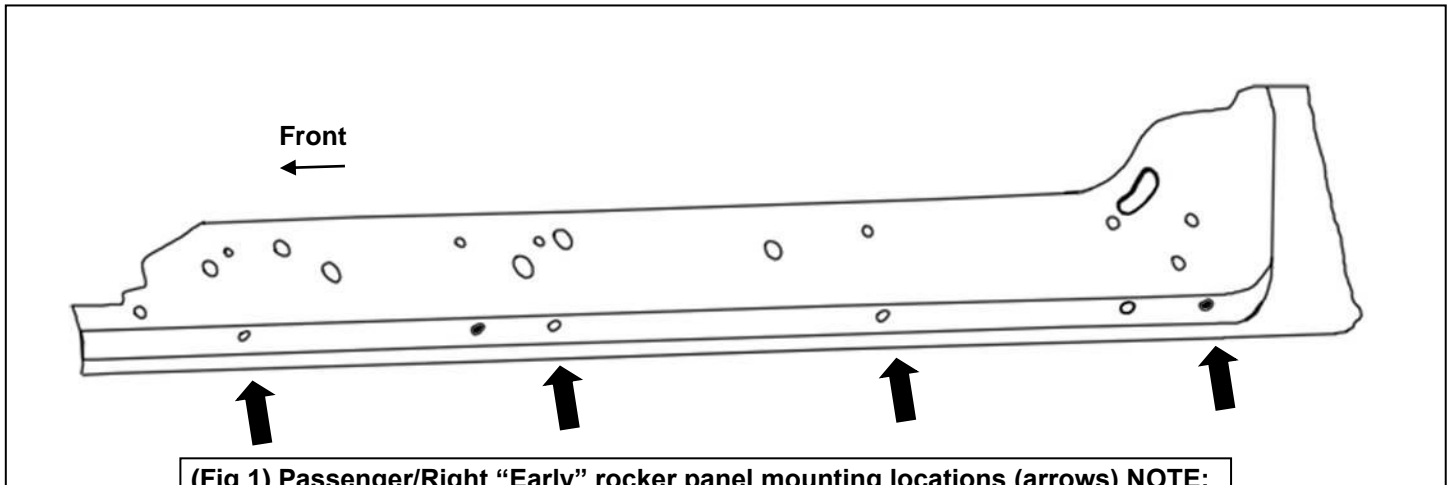

(Fig 1) Passenger/Right "Early" rocker panel mounting locations (arrows) NOTE: Hold Bracket up to body panel to help determine the correct mounting locations.

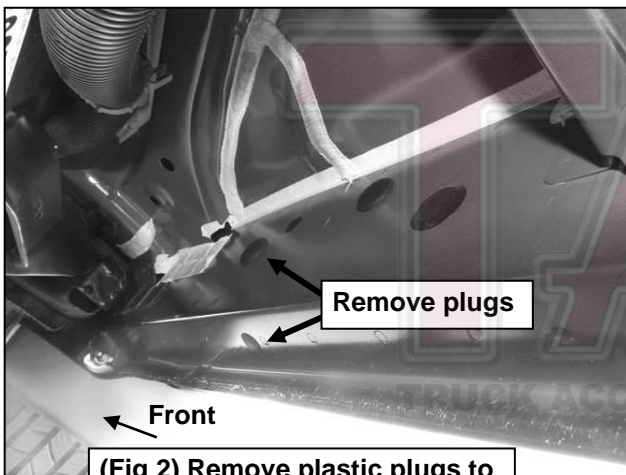

(Fig 2) Remove plastic plugs to uncover threaded inserts

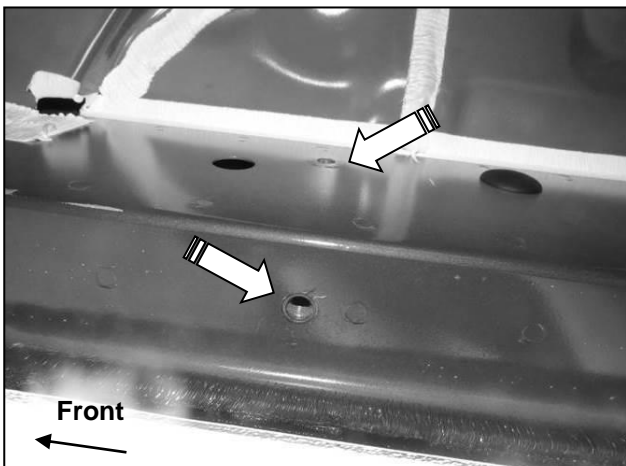

(Fig 4) Passenger/Right front mounting location

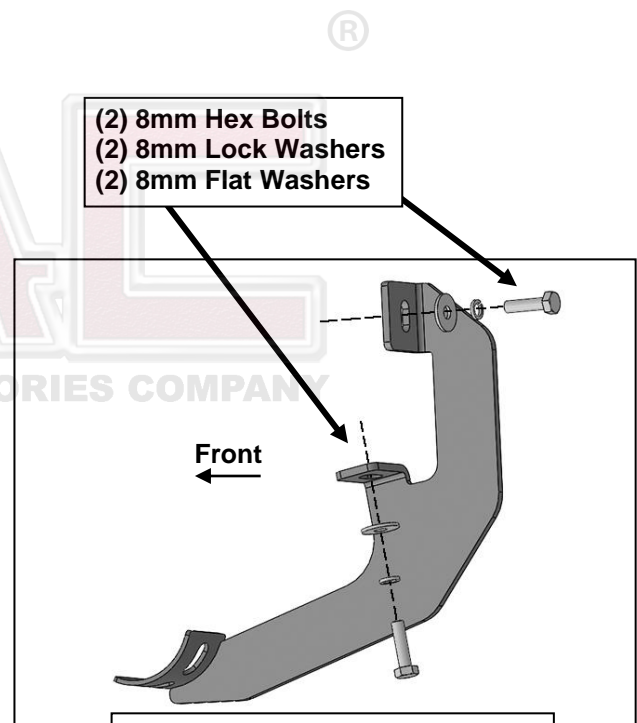

(Fig 3) Attach (1) Mounting Bracket to the mounting location

Passenger/Right side Installation Pictured

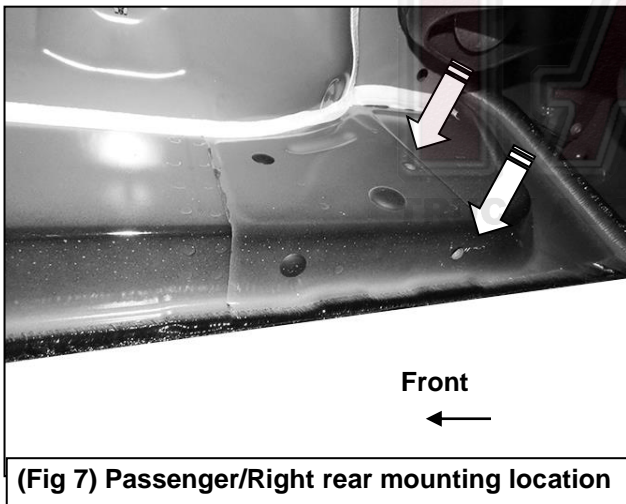
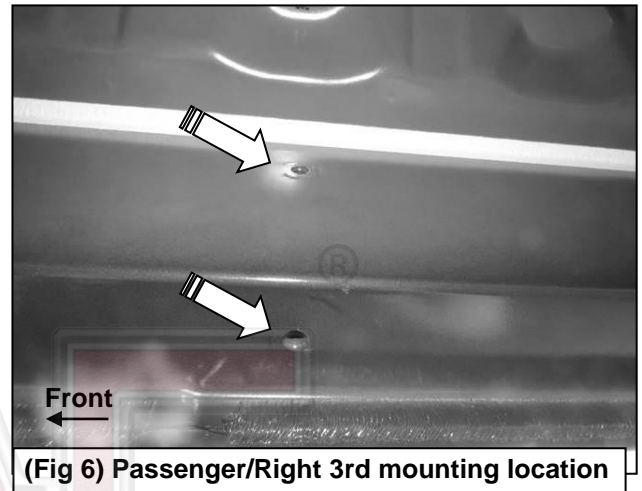
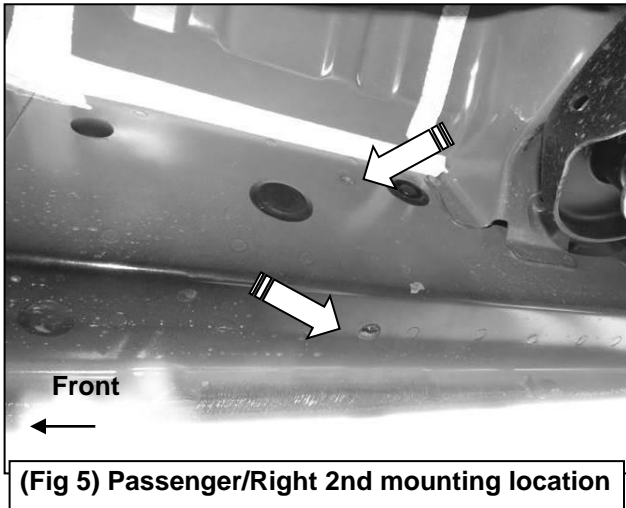

(2) 8mm Combo Bolts

