



INSTALLATION INSTRUCTIONS

3" BULL BAR
2022-2024 NISSAN FRONTIER
PART# 3B-N1130

TRUCK ACCESSORIES COMPANY

PARTS LIST:

1	Bull Bar
1	Driver/Left Side Frame Bracket
1	Passenger/Right Side Frame Bracket
4	12-1.25mm x 45mm Special Fine Thread Hex Bolts
4	12-1.75mm x 35mm Coarse Thread Hex Bolts
12	12mm x 37mm x 3mm Flat Washer
8	12mm Lock Washer
4	12mm Hex Nuts

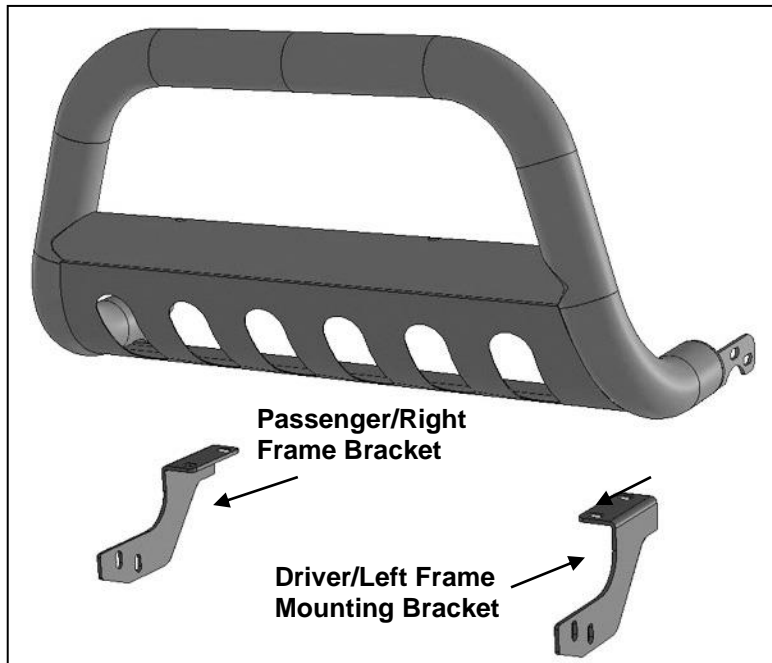

PROCEDURE:

REMOVE CONTENTS FROM BOX. VERIFY ALL PARTS ARE PRESENT. READ INSTRUCTIONS CAREFULLY BEFORE STARTING INSTALLATION. MINOR CUTTING MAY BE REQUIRED. ASSISTANCE IS RECOMMENDED. INSTALLATION MAY INTERFERE WITH FRONT SENSOR OPERATION.

1. Determine if vehicle is equipped with lower splash guard, **(Figure 1)**.

Models with splash guard.

- a. Start installation from the driver/left wheel opening. Remove the hardware attaching the inner fender liner to the edge of the fender, **(Figure 2)**. Remove the screws attaching the end of the lower splash guard to the bottom of the fender, **(Figure 3)**.
- b. Repeat previous Step to release the passenger/right end of the splash guard.
- c. Continue across the bottom of the vehicle and remove the rest of the hardware to remove the splash guard, **(Figures 1 & 4)**.

Models without splash guard. (Pro 4X model for example-see **Figure 5**). Skip to **Step 2**.

2. Remove the driver/left factory tow hook, if equipped, **(Figures 1 & 5)**.
3. Select the driver/left side Frame Mounting Bracket, **(Figure 6)**. Attach the Bracket to the tow hook location on the bottom of the frame channel with the included (2) 12mm x 45mm **Fine Thread Hex Bolts**, (2) 12mm Lock Washers and (2) 12mm Flat Washers, **(Figures 6 & 7)**. **NOTE:** Models with tow hooks, reinstall tow hook with Bracket between tow hook and frame. Do not fully tighten hardware.
4. Repeat **Steps 2 & 3** for the passenger/right side Mounting Bracket installation.
5. Carefully unwrap the Bull Bar.
6. With assistance, hold the Bull Bar up to the outside of the Brackets. Attach the Bull Bar to the Brackets with the included (4) 12mm x 35mm Coarse Thread Hex Bolts, (8) 12mm Flat Washers, (4) 12mm Lock Washers and (4) 12mm Hex Nuts, **(Figures 8 & 9)**.
7. Level and adjust the Bull Bar properly and tighten all hardware.

Models with splash guard only:

- a. Hold the splash guard up in place against the bottom of the Brackets. Mark the Bracket location onto the splash guard, **(Figure 10)**. Use a knife or hacksaw blade to cut slots out of the splash guard to clear the Brackets, **(Figure 11)**.
 - b. Reinstall splash guard.
8. Do periodic inspections to the installation to make sure that all hardware is secure and tight.

To protect your investment, wax this product after installing. Regular waxing is recommended to add a protective layer over the finish. Do not use any type of polish or wax that may contain abrasives that could damage the finish. Mild soap may be used to clean the Bull Bar.

Driver/left Side Installation Pictured



(Fig 1) Model with splash guard (arrows)

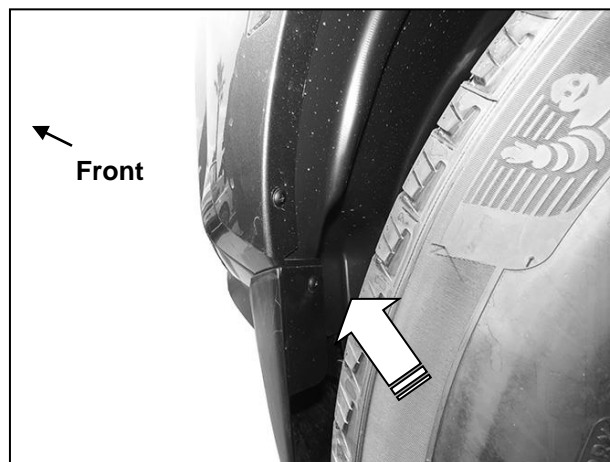

(Fig 2) Model with splash guard, remove hardware attaching end of cover to fender liner (arrow-driver/left side pictured)

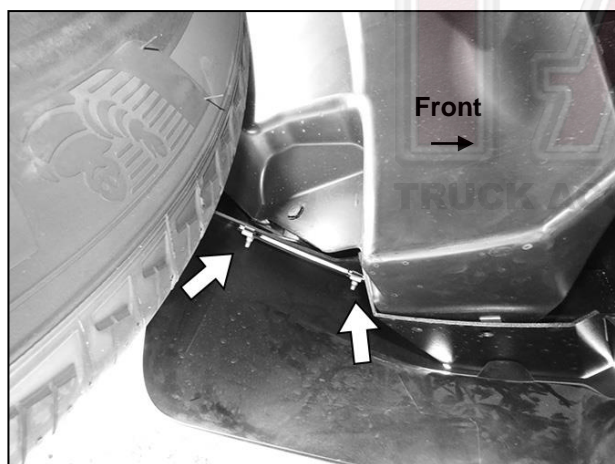

(Fig 3) Pull fender liner back to locate and remove inner screws attaching outer ends of splash guard (arrows)



(Fig 4) Splash guard removed. Driver/left side of model without tow hook pictured

Driver/left Side Installation Pictured

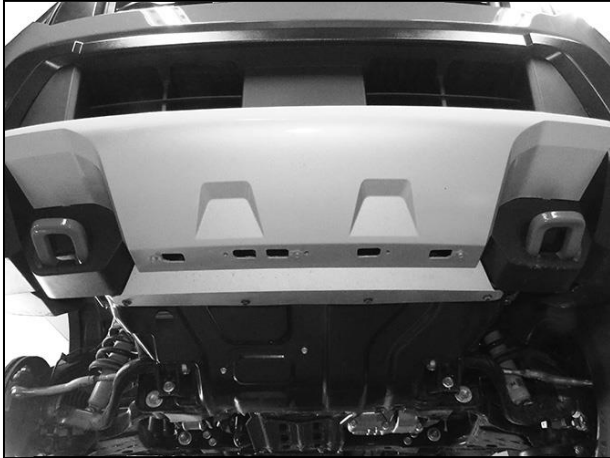

(Fig 5) Remove tow hooks if equipped. PRO4X model not equipped with splash guard pictured from below

- (2) 12-1.25mm x 45mm Fine Thread Hex Bolts
- (2) 12mm Lock Washers
- (2) 12mm Flat Washers

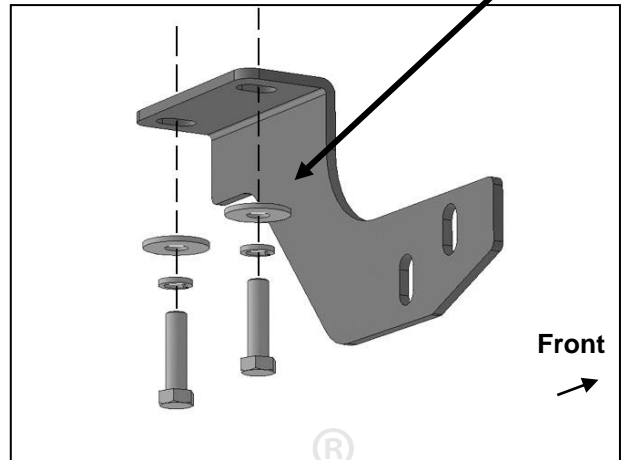

(Fig 6) Attach driver/left side Bracket

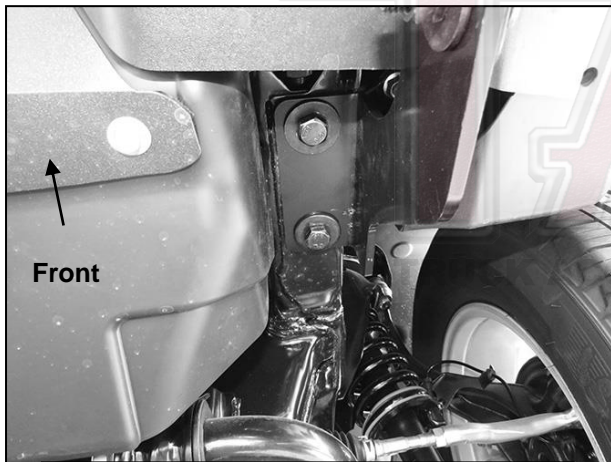

(Fig 7) Driver/left side Bracket installed. Models with tow hooks, insert Bracket between tow hook and frame

- (2) 12mm x 35mm Hex Bolts
- (4) 12mm Flat Washers
- (2) 12mm Lock Washers
- (2) 12mm Hex Nuts

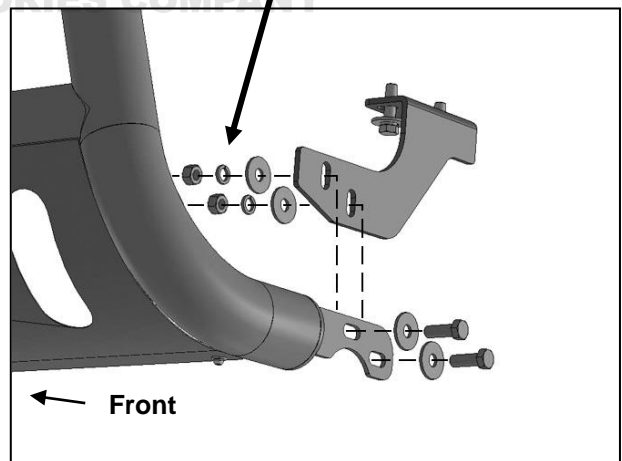

(Fig 8) Attach driver/left side of Bull Bar to outside of Bracket

Driver/left Side Installation Pictured

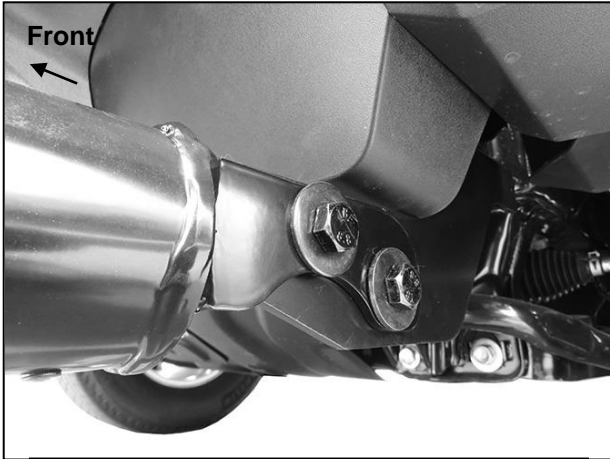

(Fig 9) Driver/left side of Bull Bar installed

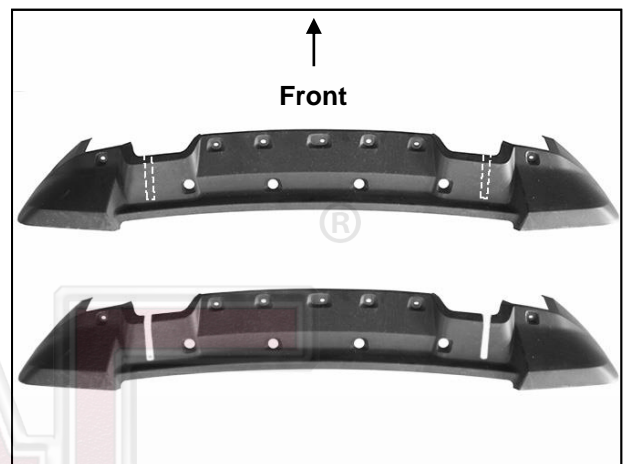

(Fig 10) Mark Bracket
location onto splash guard

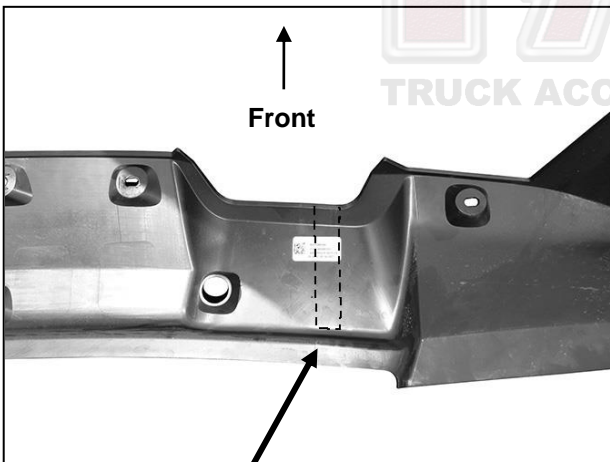

(Fig 11) Cut slots to clear the Brackets
(passenger/right side pictured, dashed
line for example only)