

EP2

Mobile LED Screen

User Manual

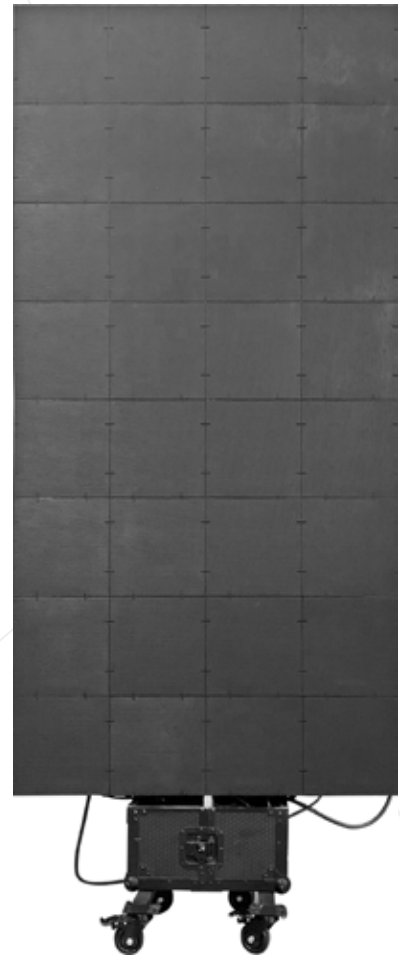



Product overview	02
Configuration and parameters	03-04
Interface identification diagram	05
Physical dimension	06
Erect installation steps	07-14
Flat lay installation steps	15-19
Remote control operation	20
Built-in asynchronous card	21
Nova system operation	22-24
Use precautions	25

Product Introduction

The EP2 is a new generation of intelligent folding display launched by Onumen Technology, It supports up to 2 meters high and can be infinitely spliced horizontally.

Indoor and outdoor optional

For indoor, P3.9 and P5.2 available. For outdoor, P7.8 with high brightness available.

Product Application

Widely used indoor and outdoor advertising and rental events.

Product Features

Small volume, fast retracting;
 Convenient and fast, saving labor and transportation space;
 Single person takes 5mins to build one set screen by 3 steps.

Patent

EP2 have obtained many domestic and international certifications and patents: RoHS, CE, FCC, TUV, etc.





The whole parameter

Size:	1390mm*409mm*323mm
Weight:	62kg
Input Voltage:	AC1100-240V 50/60Hz
Max Power Consumption:	1000W
Storage temperature:	-40°C-80°C
Storage humidity:	0%-95% RH
Protection level:	indoor IP43 Outdoor IP65

Screen Parameter

Screen body:	Indoor: P3.9, P5.2, 850NITS, IP43 Outdoor: P5.2, P7.8, 6000NITS, IP65
Weight of the screen body:	12kg/sqm
Screen size:	1mWx2mH
Work voltage:	DC24V

Remark: There is one screen in one flight case, screen size is 1mWx2m H.



Parameter for electric lifting rod

Weight:	最大5.5kg
Load-bearing:	最大50kg
Working Voltage:	DC24V
Working Current:	1A The Max. 1A
Stretch speed:	Up to 17mm/second
Mode of operation:	Remote control

Parameter for control box

Asynchronous card:	Nova T1,wifi, Control up to 650,000 pixels
Power Supply:	Meanwell RSP1000W-24
External battery or DC power supply:	DC24V
Reciveing card:	Nova A4S
Signal output interface for screen body:	2+13*4pcs
Motor interface for Pushrod:	2PIN Plug
Weight:	8kg
Remark:	One control box in one flight case



Interface labeling diagram

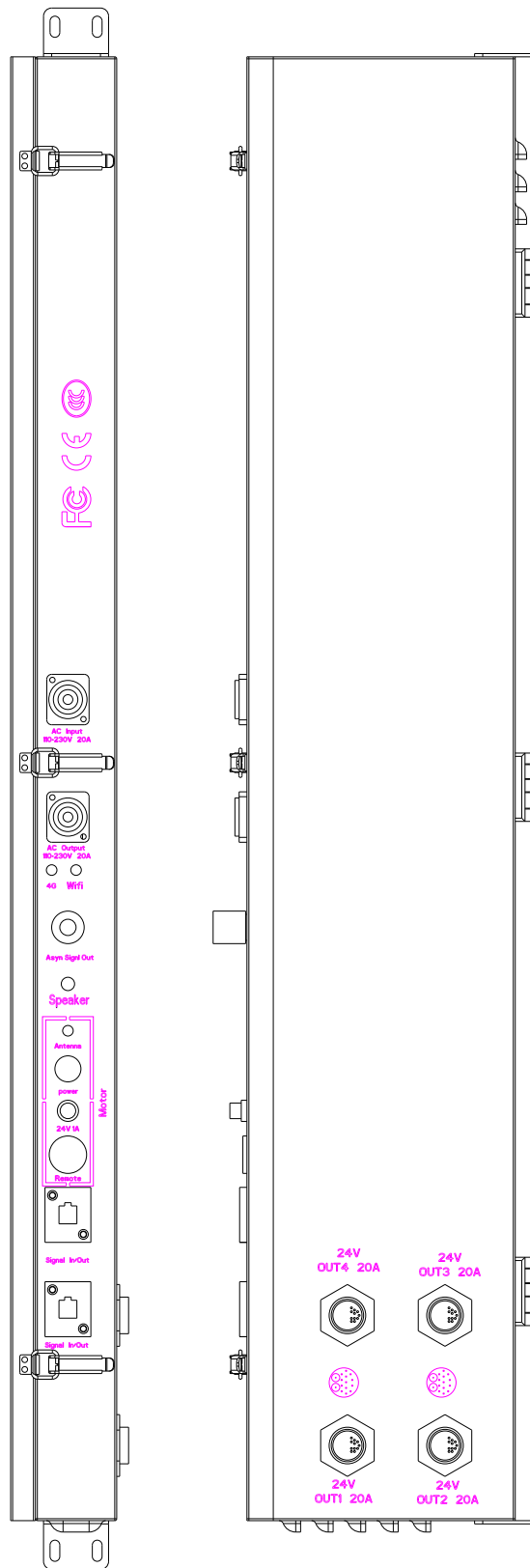





Erect installation steps

1 Open flight case.

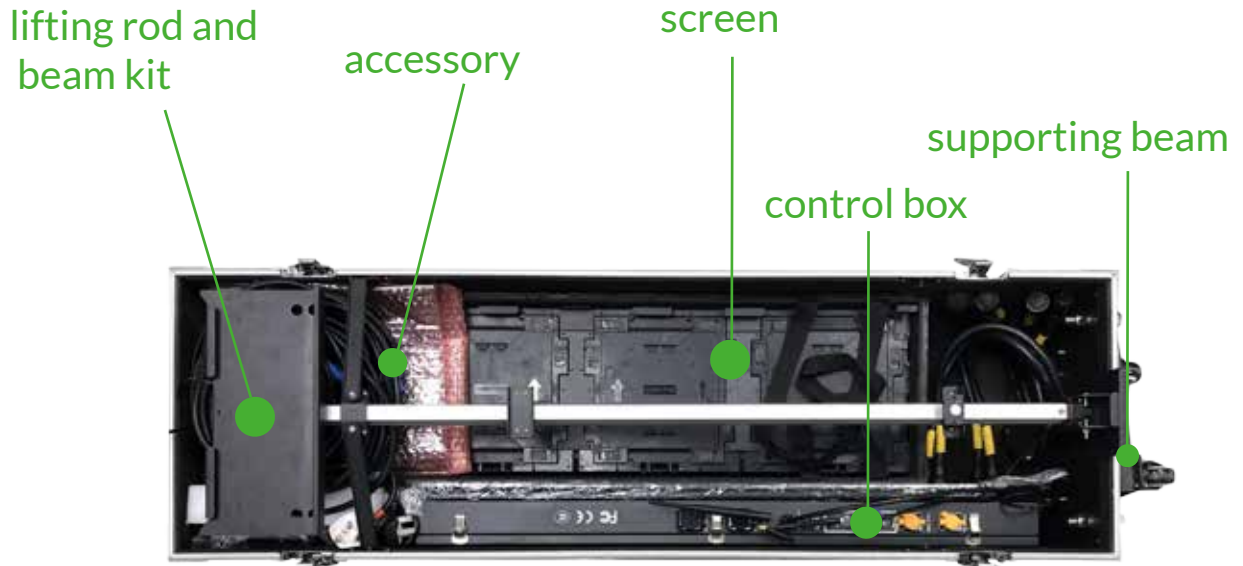

2 Open the buckles at both sides of the electric lifting rod.

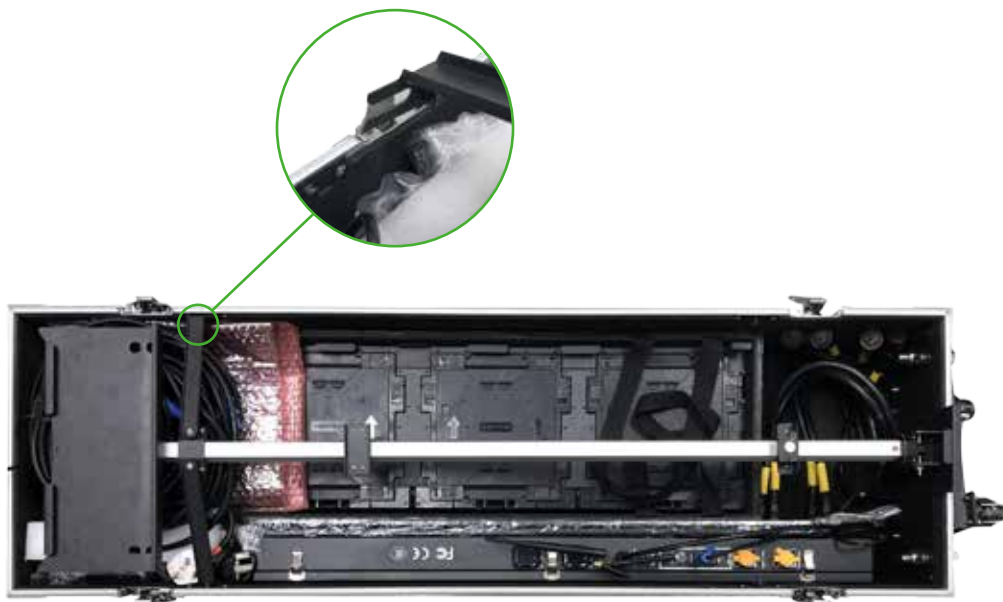



- 3 Erect the electric lifting rod and take out the screen box and all accessories.

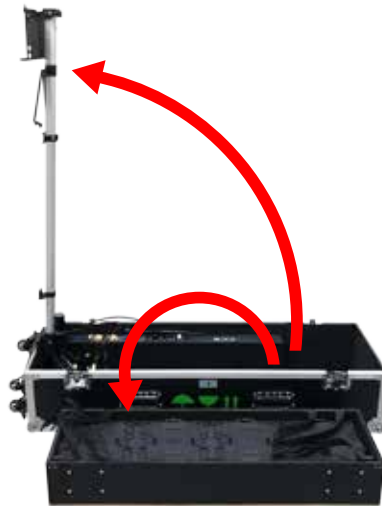

- 4 Lie down the electric lifting rod and fasten the buckle, and open the front support feet to the maximum extent.





Erect installation steps

- 5 Erect flight case, pull out the control lines, plug in the main power cable and press the "power" switch.

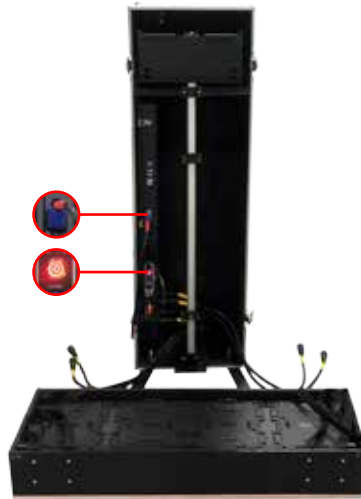

- 6 Hang the screen on the electric lifting rod, push the remote control switch to rise screen above the flight case, press pause.





- 7 Fasten one end of the back pull wire rope to the screen hanger, and put the wire rope to the back of flight case.



- 8 Continue to rise the screen before the third screen height, adjustable hook at the bottom end of the back wire can adjust the verticality of the lifting rod.

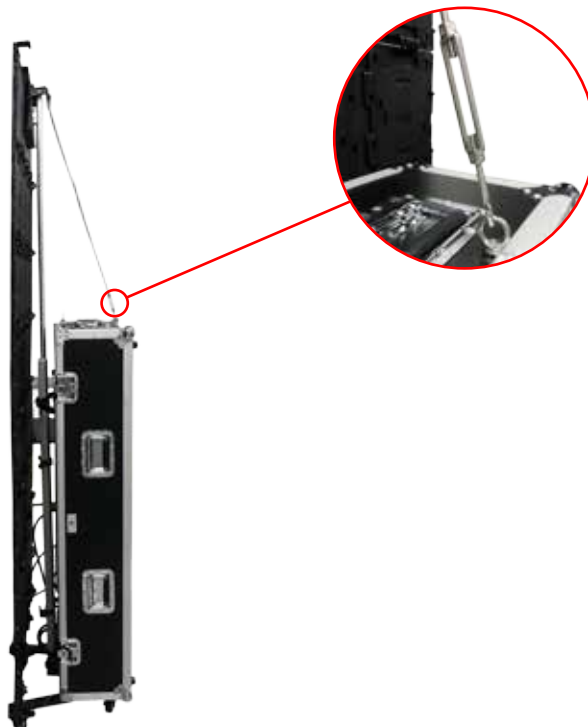



Erect installation steps

- 9 Turn the remote control switch to “F” to turn off, turn off the “Power” switch on the control box, and turn off the main power. Connect the screen control cables in turn, from left to right OUT1~OUT4.

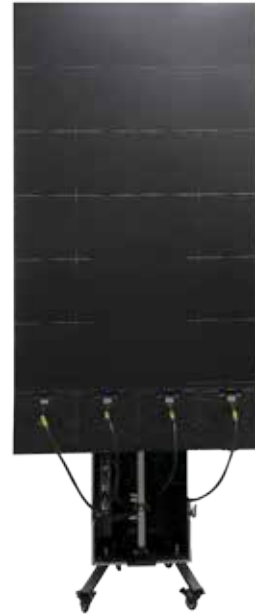

- 10 Plug in the power cable to light up screen (single unit installation completed).





Erect installation steps

- 11 When splicing multiple sets, take out the splicing connecting pieces and buckle the connecting piece into the hook at the screen splicing.

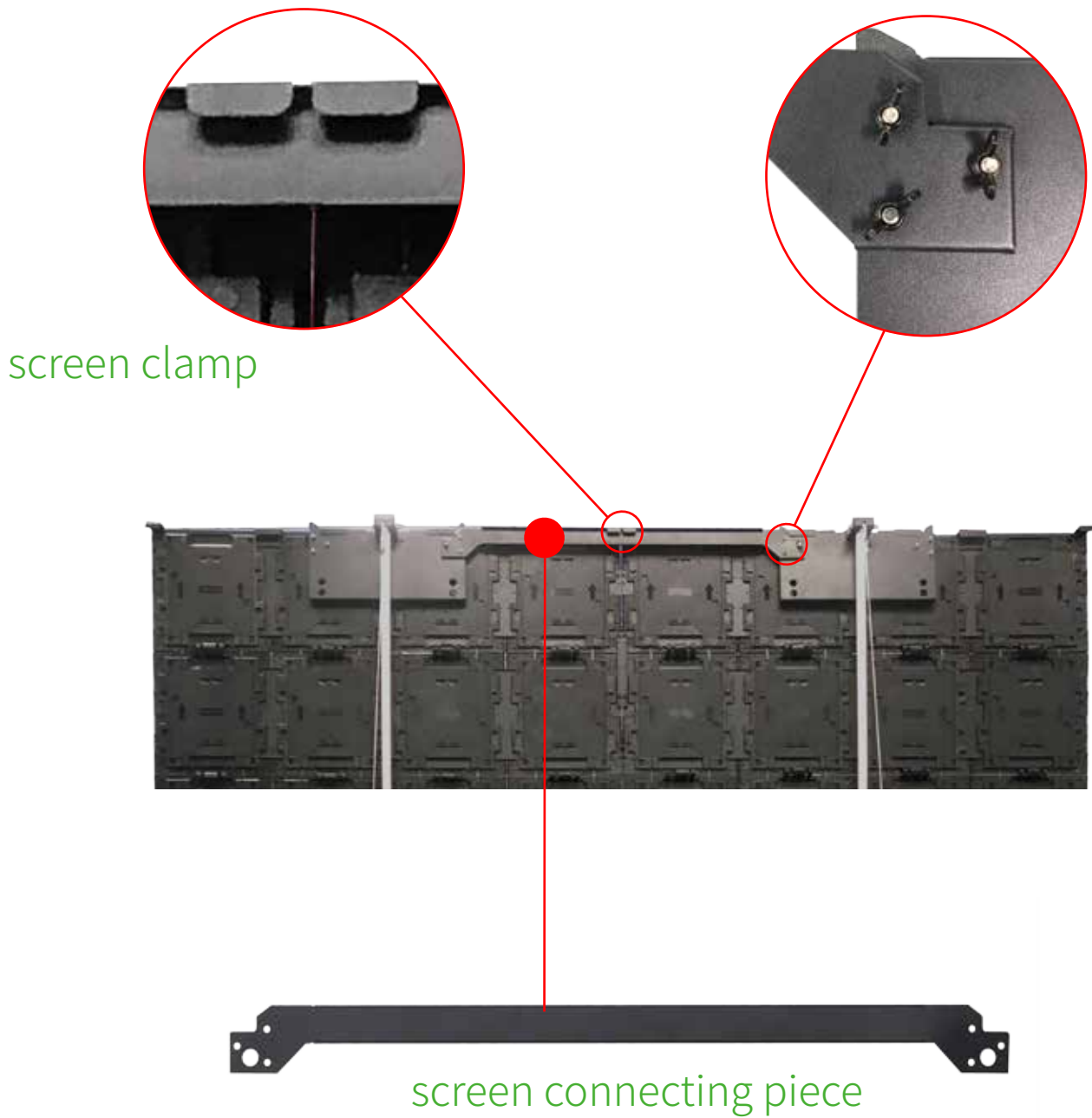



- 12 The screen is spliced with four corner connectors, one for each two lines.

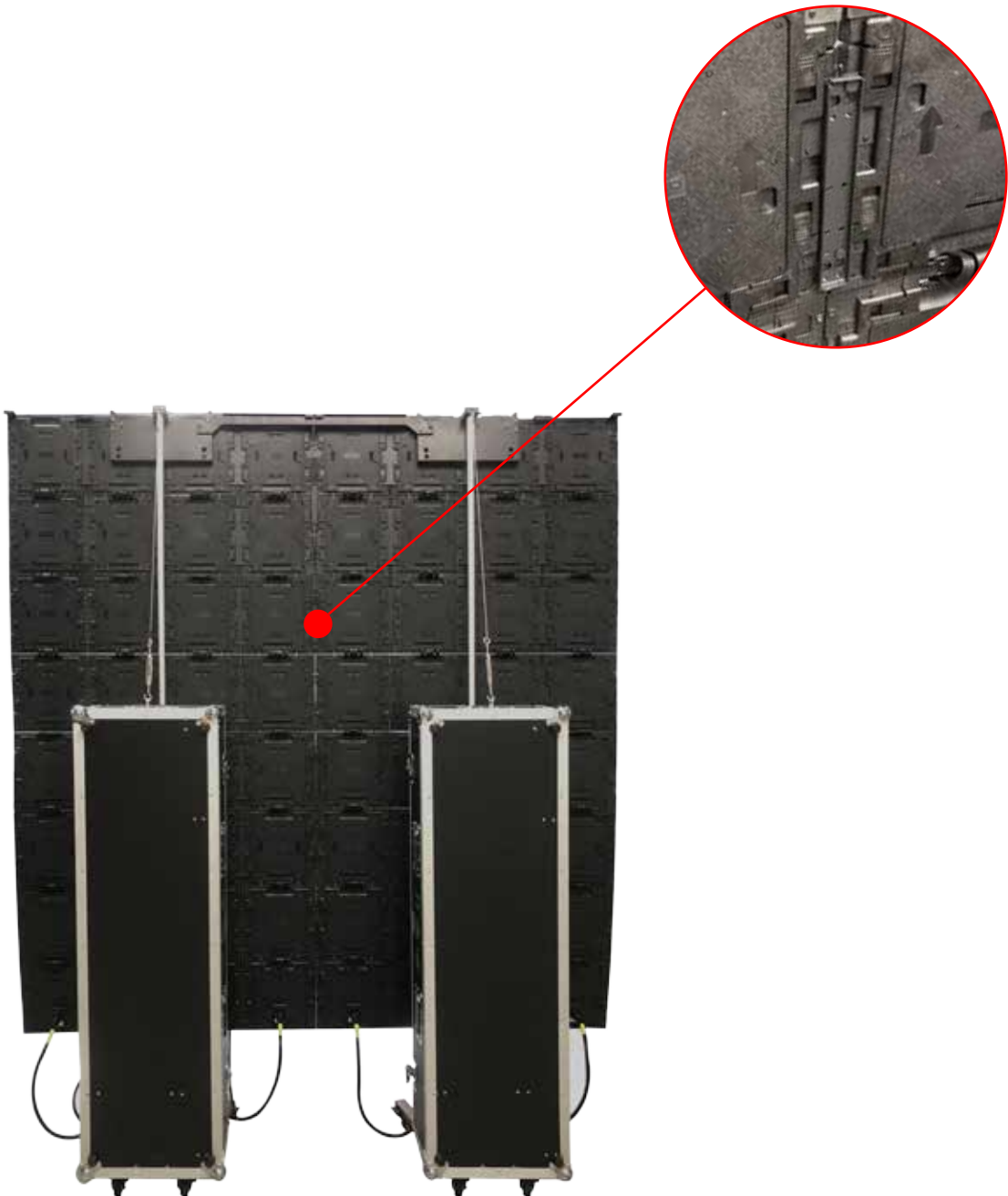



Erect installation steps

13 Multiple splicing completed.





1 Open flight case.

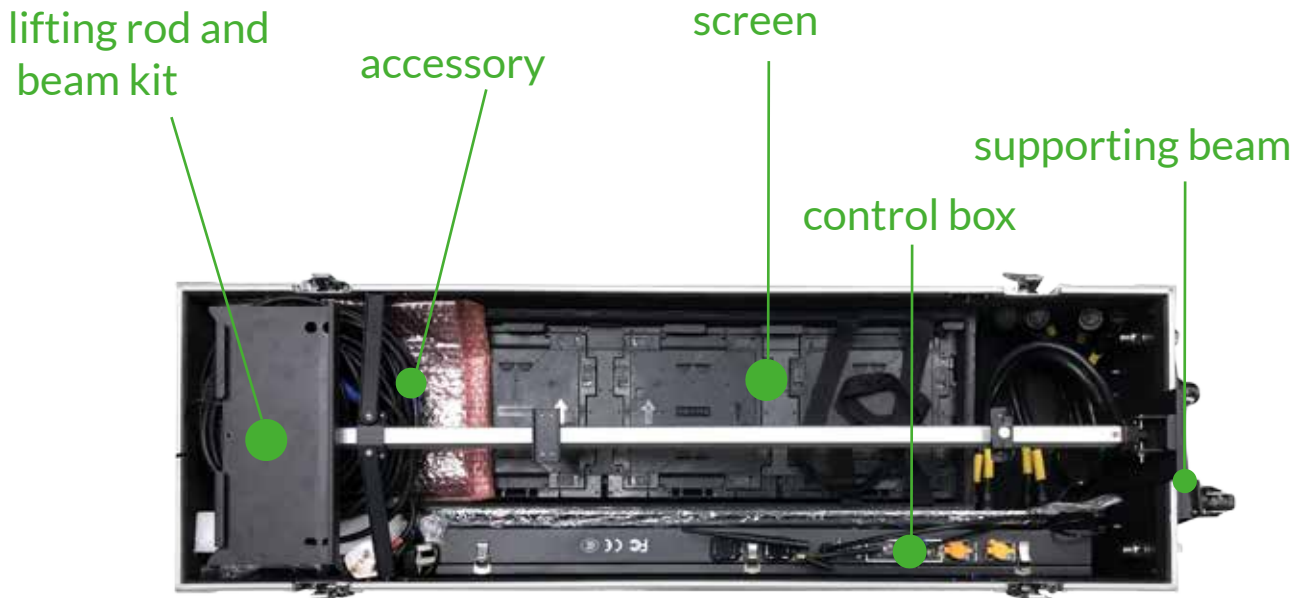

2 Open the buckles at both sides of the electric lifting rod.

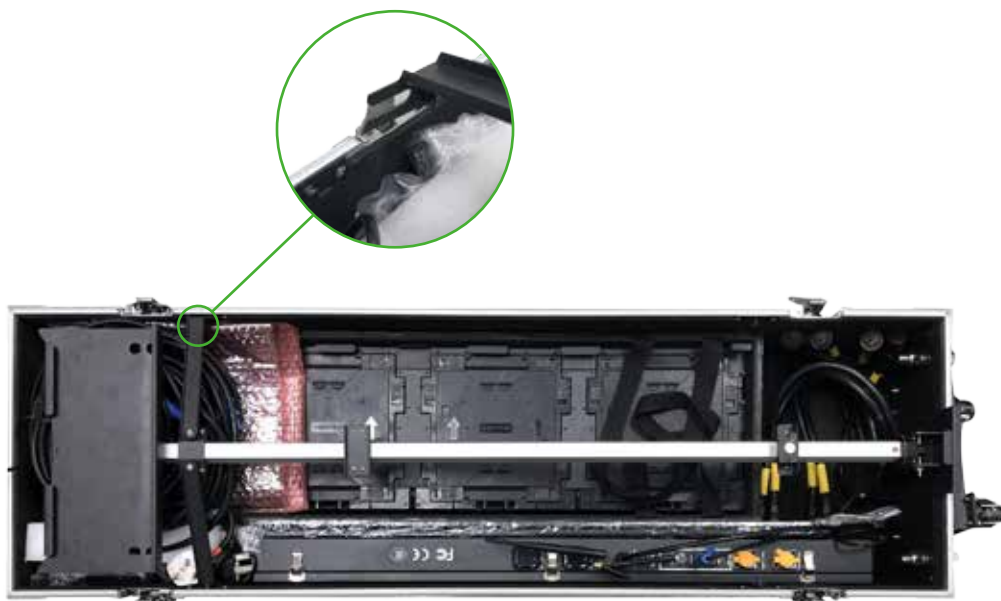



Flat lay installation steps

- 3 Erect the electric lifting rod and take out the screen box and all accessories.



- 4 Move the screen to the front and take out the two flat support rods. One end is fixed on the electric lifting rod and the other end is fixed on both sides of the box.

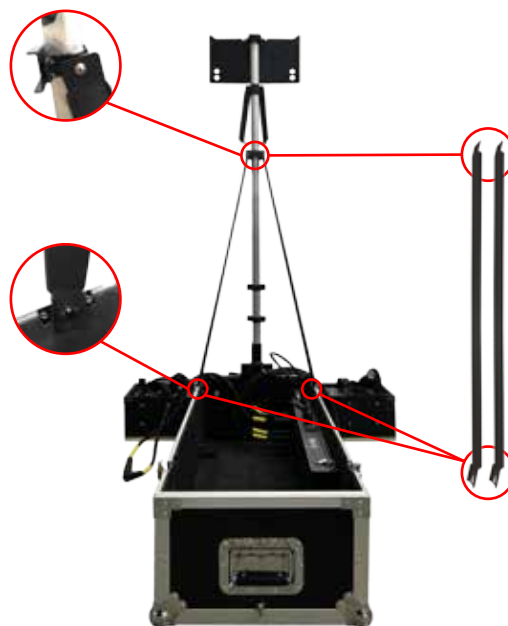



5 Hang the screen on the bearing frame.



6 Plug in power cable to feed power, press the "power" switch of the electric lifting rod and the red light will be on.





Flat lay installation steps

- 7 Take out two wire ropes and connect them into one, One end of which is buckled on the screen hanger and the other end is buckled into the box ring buckle.

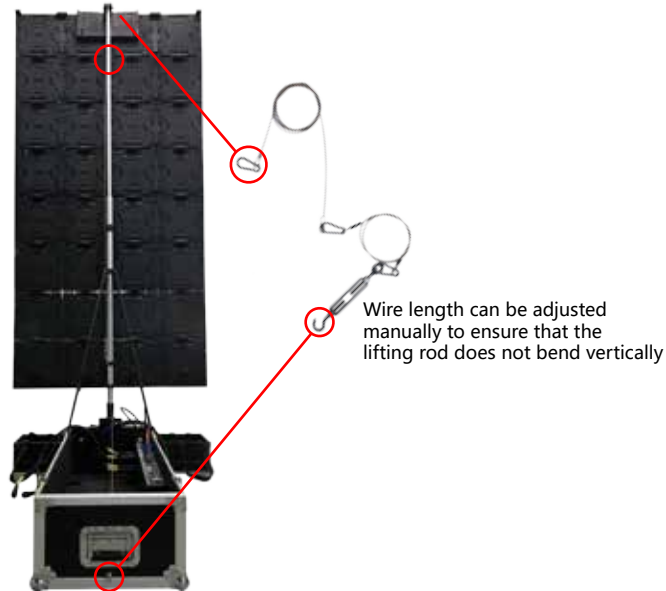

- 8 Take out the remote control and pull out the antenna, push the remote control switch to "N" and press " Δ " key to raise the screen completely.

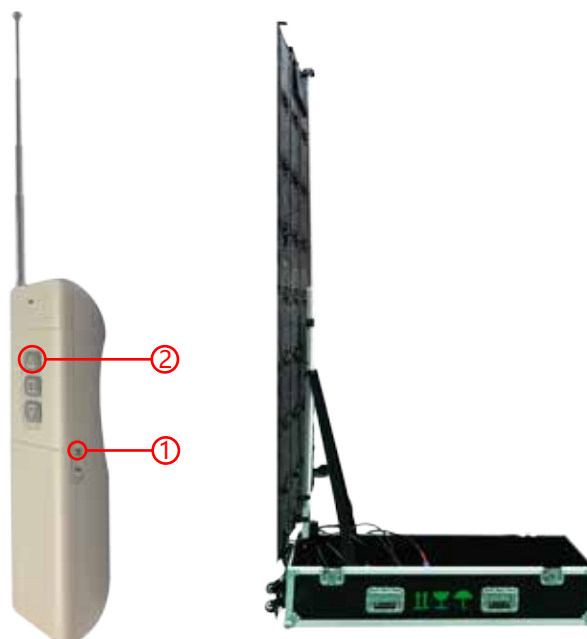



- 9 Turn off the "Power" switch of electric lifting rod, the red light is off, cut off the main power supply.

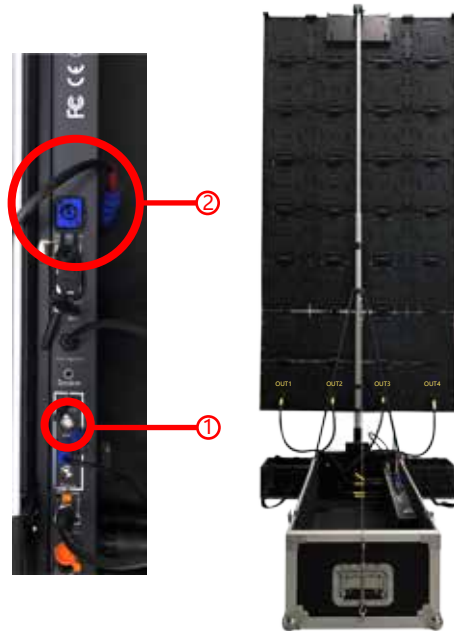

- 10 Plug in the power cable to light up screen.





Code matching button and remote control picture



Remote control code button



Remote control

The operations are as follows:

Clearing Method :

Code matching method:

Press the learning button once, the indicator light flashes slowly, immediately press the "A" button on the remote control, flashing 4-5 times quickly, It indicates that the "A" key has been successfully learned. Press the "B" key twice to learn and the blinking pattern is the same as above (Note: The remote controller does not have a learning value as a stop function in the "interlock" mode. The learning waiting time is about 6S. Automatically exit the learning mode after success)

Code method:

Turn on the power, press the code button on the receiver board, then the indicator light is always on, then start to press the remote control to perform the code. Press the remote control A (up) button first, the receiver indicator will flash four times, then Press the remote B (down) button, the indicator light flashes four times, complete the code. At this point, the remote control can control the operation.

Add remote control :

If add more than one remote controller on the basis of the original remote controller, just follow the steps of the code matching method. Adding the remote controller does not need to clear the code! The receiver can code 18 remote controls with different codes. If there are more than 18 remote controls, the first remote control will automatically fail! There are countless remote controls of the same code.

Pushrod remote supports the following function:

- One remote control to control a lifting rod
- One remote control controls multiple lifting rod
- Multiple remote controls for one lifting rod
- Multiple remote controls for multiple lifting rod



Use built-in asynchronous card



Pull out the network cable when using asynchronously

When using asynchronous, connect the asynchronous signal cable to one of the signal ports.

Not use built-in asynchronous card



Connect the network cable when using synchronously

When asynchronous is not used, unplug the asynchronous signal cable.



The Operation Of Nova System

- 1 This product is equipped with Nova system, you can go to Nova official website for related information.

www.novastar-led.cn



- 2 This product is equipped with Nova T1 multimedia player card. For related functions and operations, please view the TB1 specification download . in the official website www.novastar-led.cn.

www.novastar-led.cn

- 3 Please Download software **NovaLCT V5.2.0** for configuration parameter, The parameter setting of the product has been debugged at the factory. When the customer is in use, generally only need to use:

parameter sending

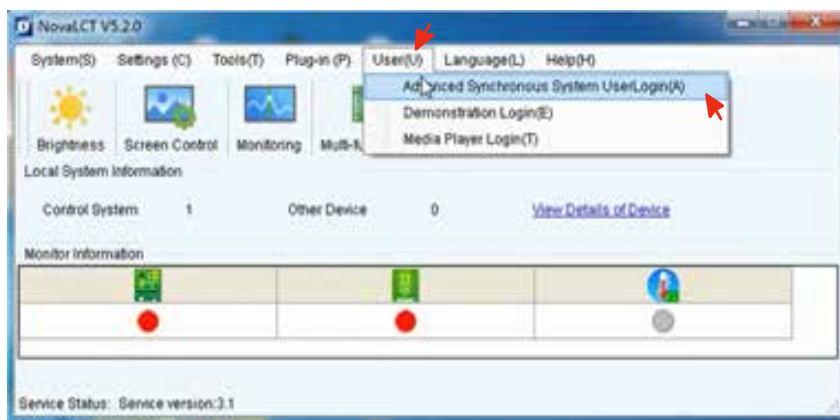

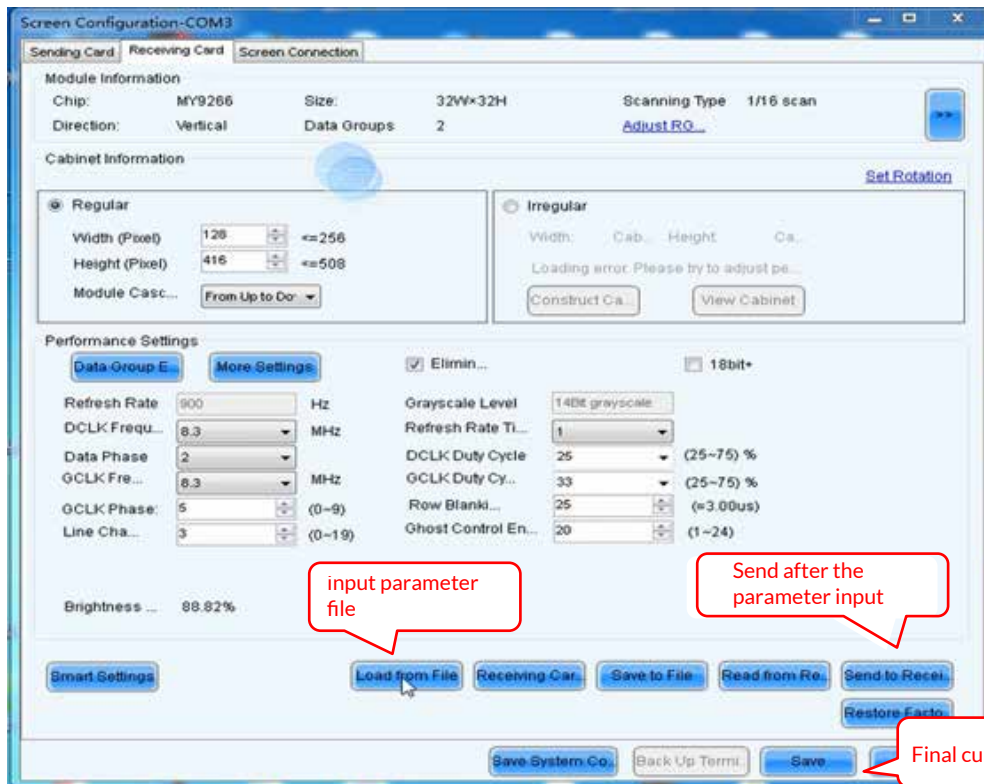
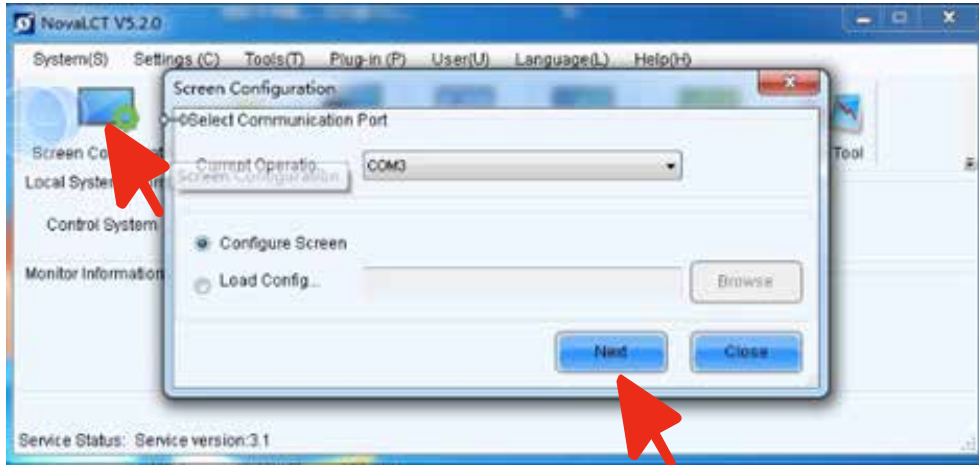



The Operation Of Nova System

Brightness adjustment

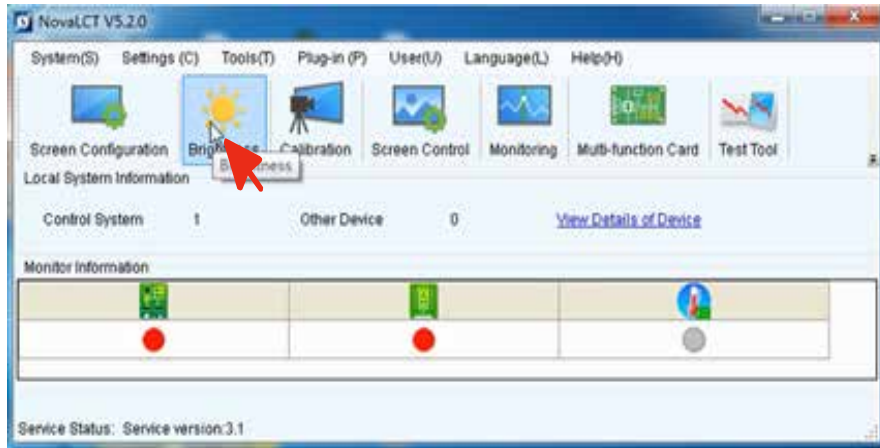

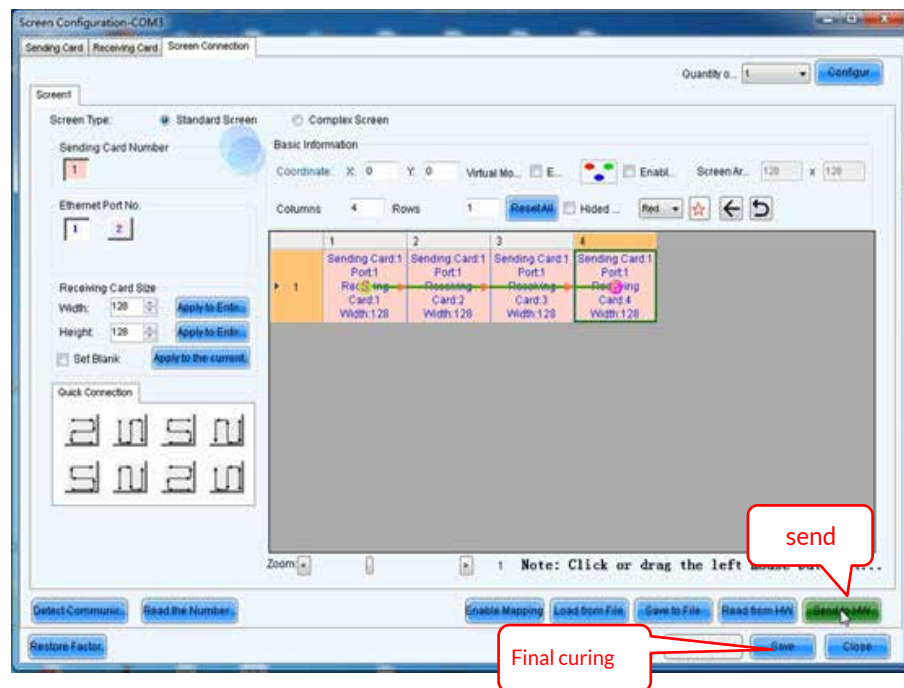

For detailed operation, please refer to the **NovaLCT V5.2.0** user manual. If you still have any problems, please consult our technical staff.

- 4 For video transmission software, please download ViPlex, video transmission support PC transmission and mobile phone transmission (Mobile version of Viplex Handy and PC version of Viplex Express, please download and install). For details, please refer to the ViPlex Express user manual. If you still have any problems, please consult our Technical staff
- 5 Asynchronous playback also supports Nova's remote VNOX cloud release, which enables remote management of products through the Internet, and changes to broadcast programs. For details, please view the website <http://www.vnox.com>, Vplayer Software Download The user manual can be viewed directly on the download page. Nova's remote cloud release is currently a paid service. Need permission and annual fee to use. If necessary, please contact us directly or contact Nova directly.





1、 Screen

- a.The power must be turned off before connecting and unplugging the control cables
- b.When hanging the screen, be sure to hang the hook to avoid the hook off the screen.

2、 Remote control operation

- a.There is a switch on the right side of the remote control. When using it, pull it to "N". When not in use, pull it to "F".

Please don't keep it on, avoiding misuse!

- b.Always pay attention to the operation of the remote control during lifting, and let the lifting rod stop when encountering abnormal conditions!

c.When using the "1 control multi", the remote control recommends pressing 2-3 times each time. Avoid individual products that are not receiving information in time without being controlled!

- d.After each rise and fall, you should press the "□" stop button on the remote control again!

e.If you find that the remote control cannot control the rise or fall, immediately turn off the main power supply, then power on and try to check the cause!

- f.When the remote control is found to be less sensitive or often uncontrolled, the remote control battery may be insufficient or the remote control may be damaged,pls replace in time!

3、 Electric lifting

- a.The "POWER" button on the control box is to control lifting rod. It can only turn off lifting rod, cannot turn off the screen. It only opens when the lifting rod is required to be lifted and lowered.

Please turn it off when not in use to avoid accidents caused by accidentally pressing the remote control!

- b.The lifting should be completed several times in sections. During the lifting process, pay attention to the lifting rod, back pull wire rope, screen body, Cables, etc. will not got stuck, always pay attention to stop lifting!

c.After fully lowering, the back pull wire rope should be taken off to avoid accidents when it rises again!

4、 Installation

- a.After the supporting frame is installed, first check whether the lifting rod is stable, whether the top rack is loose, and the support fixing components on the lifting rod are firmly installed!

b.The front support legs of the frame should be opened to the maximum in an "eight" shape.