

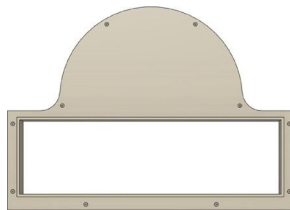

Undercabinet Range Hood



6" Top
Round Adapter



3-1/4" x 10" Top
Rectangular Adapter



3-1/4" x 10" Rear
Rectangular Adapter

- * 3 adapters and 1 top cover are included.
- * 1 remote control is included.

EMPV-30RH11/36RH12

Installation Guide and Users Manual



EMPAVA APPLIANCES INC

15253 DON JULIAN RD CITY OF INDUSTRY, CA 91745

TEL: 888-682-8882

WWW.EMPAVA.COM

Steps To Test Run Before Installation

IMPORTANT!

Wear gloves to protect against sharp edges.

PLEASE FOLLOW THESE INSTRUCTIONS TO TEST THE RANGE HOOD BEFORE INSTALLATION FOR ANY DEFECTS OR SHIPPING DAMAGE:

1. Remove the range hood and accessories from the package carefully.
2. Place the range hood on a flat stable surface, remove the baffle filter and check for any dents or damages on the range hood body.
3. Remove the loosen parts if there's any.
4. Plug the range hood into a 120V AC power source.
5. Check each speed variation and pay attention to the noise level to make sure there isn't any unusual noise besides it coming from the wind blowing. Press the Light Button to check the lights.
6. Verify all functions, as instructed in Page 9, are working properly.
7. Refer to Range Hood Troubleshooting in Page 11 for general issues and solutions.

Please read all instructions carefully before proceeding further to prevent the risk of fire, electric shock, personal injury or damage to the range hood. This manual provides a general insight on the installation and may not include solutions for all possible issues that may occur.

In case of this manual destroyed or lost, please visit <https://www.empava.com> and download a digital version.

Installation Overview

1. Unpack the range hood and check for any physical damage on the body.
2. Test run the range hood and check if all functions are working properly. Refer to Page 9 for functionalities.

DO NOT install the range hood if it's defective. Contact the seller immediately.

3. If all is fine, install the range hood as instructed in this manual. Refer to Page 7 & 8.
4. Test run the range hood again when the installation is finished. Refer to Page 11 for troubleshooting.

Possible Tools Needed:

- Marker / Pencil;
- Jig Saw or Reciprocating Saw;
- Screwdrivers or Power Drill;
- Level;
- Measuring Tape;
- Knife;
- Duct / Foil Tape;
- Screws.

2 PEOPLE ARE REQUIRED FOR THE INSTALLATION.

Table of Contents

Important Safety Instructions	4
Installation Preparations	5
Venting Requirements	5
Venting System Setup	5
Duct Run Calculation Chart	6
Electrical Requirement	6
Installation	7
Installing the Range Hood	7
Connecting the Vent System	8
Electrical Connection	8
Installing the Baffle Filters	8
Completing the Installation	8
Range Hood Use	9
Range Hood Control Panel	9
Range Hood Care	10
Clean the Exterior Surfaces	10
Clean or Replace the Baffle Filters	10
Replace the LED Lamps	10
Range Hood Troubleshooting	11
Warranty	12

IMPORTANT SAFETY INSTRUCTIONS

TO REDUCE THE RISK OF FIRE, ELECTRIC SHOCK OR PERSONAL INJURY, PLEASE READ THE FOLLOWING CAREFULLY BEFORE ATTEMPTING TO ASSEMBLE, INSTALL, OPERATE OR MAINTAIN THE RANGE HOOD:

- Always disconnect, lock and tag the power source before installing or servicing the range hood. Failure to do so may result in fire, shock or serious injury.
- Installation and electrical wiring must be done by qualified technician(s) in accordance with all applicable codes and standards, including fire-rated construction.
- When cutting or drilling into walls or ceilings, please be careful not to damage any electrical wirings and other hidden utilities.
- Verify and ensure the rated voltage and frequency of the range hood is in compliance with the nearby power source.
- Always unplug the range hood from the power source before cleaning it.
- Use the range hood only as directed in this manual. Do not use it to vent hazardous or explosive materials or vapors.
- Clean the baffle filters regularly to prevent it become blocked or clogged. Good air flow is essential for the range hood to work properly.
- Do not install, repair or replace any parts of the range hood unless you are instructed to do so by the manufacturer.
- Do not tamper with or modify the PCB.
- This range hood model requires a duct to vent the air outside. Do not vent the air into spaces within walls, ceilings, attics, crawl spaces or garages.

TO REDUCE THE RISK OF A RANGE TOP GREASE FIRE:

- Never leave surface units unattended at high settings. Boilovers cause smoking and greasy spillovers that may ignite. Heat oils slowly on low or medium settings.
- Always turn the hood ON when cooking at high heat or when flambeing food (i.e. Crepes Suzette,

Cherries Jubilee, Peppercorn Beef Flambé).

- Clean ventilating fans frequently. Grease should not be allowed to accumulate on the fan or filter.
- Use proper pan sizes. Always use cookware appropriate for the size of the surface element.

TO REDUCE THE RISK OF INJURY TO PERSONS IN THE EVENT OF A RANGE TOP GREASE FIRE:

- **SMOTHER FLAMES** with a close-fitting lid, cookie sheet or metal tray, then turn off the burner. **BE CAREFUL TO PREVENT BURNS.** If the flames do not go out immediately, **EVACUATE AND CALL THE FIRE DEPARTMENT.**
- **NEVER PICK UP A FLAMING PAN** - you may be burned.
- **DO NOT USE WATER**, including wet dish cloths or towels - a violent steam explosion may result.
- Use a fire extinguisher **ONLY** if:
 - You have a Class ABC extinguisher, and you already know how to operate it.
 - The fire is small and contained in the area where it started.
 - The fire department is being called.
 - You can fight the fire with your back to an exit.

TO REDUCE THE RISK OF PERSONAL INJURY IN THE EVENT OF A GAS LEAK:

- Extinguish any open flame.
- **DO NOT** turn on the lights or any type of appliance.
- Open all doors and windows to disperse the gas. If you still smell the gas, call the gas company, fire department, or 911 immediately.

Read and Save These Instructions

INSTALLATION PREPARATIONS

Venting Requirements

DO

- Have the venting system go vertically from the range hood to the roof if possible.
- Have 24"-30" distance between the cooktop and the range hood. 27" is recommended.
- Use uniform duct of 6" round duct or 3-1/4 x 10" rectangular duct or larger.
- Use metal duct only. Rigid metal duct is recommended. Semi-rigid aluminum duct is also acceptable for easy connection. Please refer to your city building code for vent requirement.
- Make sure there is a minimum of 24" of straight vent between the elbows if more than 1 elbow is used.
- Use minimal numbers of elbows and the shortest route for the venting system for a better performance.
- Use aluminum foil tape or duct tape to seal all joints in the venting duct system.
- Use caulking silicone to seal exterior wall or roof opening around the cap.
- Always keep the duct clean to ensure proper airflow.

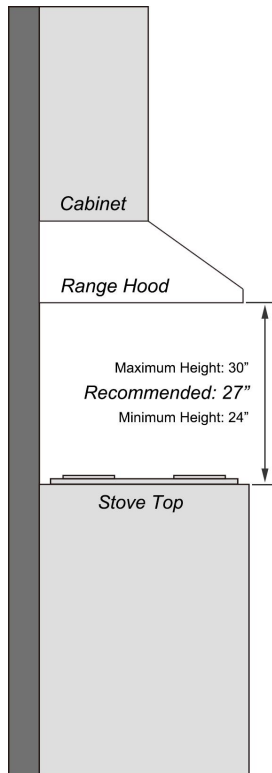

DO NOT

- End the venting system in an enclosed area indoors.
- Use plastic vent.
- Use no more than three 90° elbows.
- Install 2 elbows together.
- Install the range hood outside of the recommended height.
- Reduce the duct size below the recommended size.

Venting System Setup

- This range hood can be:
 - 6" top venting through the roof or wall.
- or
- 3-1/4 x 10" top or rear venting through the roof or wall.

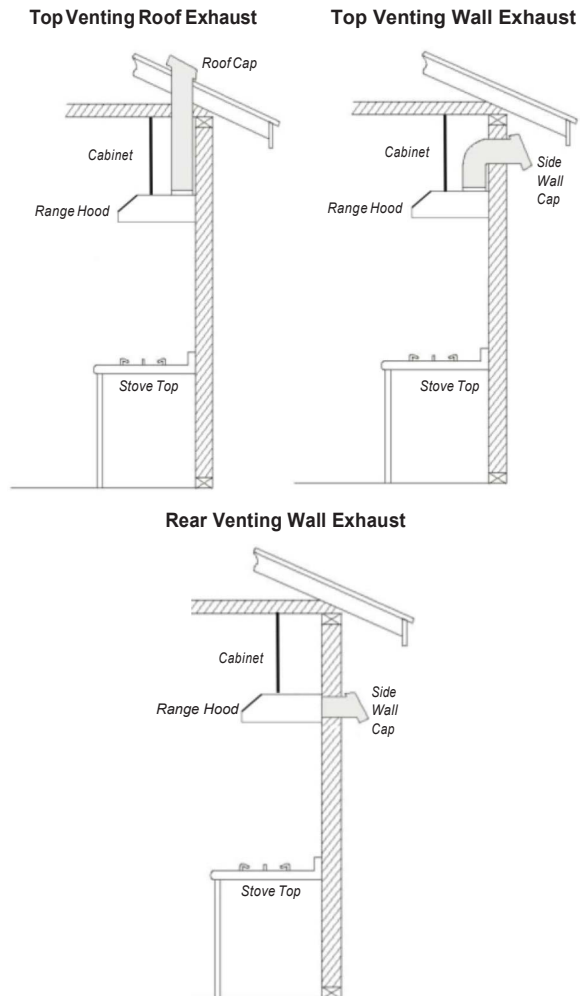

INSTALLATION PREPARATIONS

IMPORTANT!

- If long duct run is needed, increase the duct size from 6" to 7" or 8" to 9".
- If a reducer is needed, use a long reducer instead of a pancake reducer and install it as far away from the range hood as possible. Reducing the duct size will restrict and decrease the speed of the airflow and hence lower the range hood's performance.
- If transitions or turns are needed, install them as far away from the range hood as possible and keep the distance between the 2 as far apart as possible.
- The minimum mounting height should be no less than 24" and the maximum mounting height should be no more than 30".
- Also refer to the owner's manual of the stove top for the height clearance requirement and the recommended mounting height above the range.

Note

- *It is important to install the range hood at the proper mounting height. Hoods mounted too low could result in heat damage and fire hazard while hoods mounted too high will be out of reach and hence reduce its performance and efficiency.*

Minimum Duct Size:

- Round: 6" minimum.
- Rectangular: 3-1/4" x 10" minimum.

Product Dimension

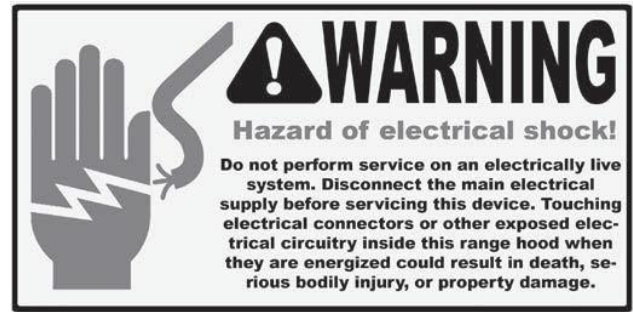
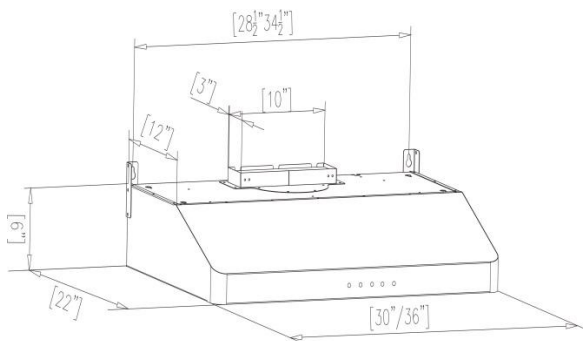

IMPORTANT!

Observe all governing codes and ordinances.

It is the customer's responsibility:

- To contact a qualified electrical installer;
- To ensure that the electrical installation is in compliance with applicable codes and standards.

Electrical Requirements:

- A 120V, 60Hz., AC only, 15A fused electrical circuit is required.
- Wire sizes and connections must conform with the power rating of the range hood and all applicable codes and standards.
- DO NOT have a fuse in the neutral or ground circuit.
- The 3-prong outlet should be grounded. If the power cord plug is not used, the power cord's green wire should be connected to ground. Check with a qualified electrician if you are not sure that the range hood is properly grounded.
- DO NOT ground to a gas pipe.
- The range hood must be connected with copper wire/plug only.
- The range hood should be connected directly to the fused disconnect box (or circuit breaker) through flexible armored or non-metallic sheathed copper cable. ETL listed strain relief must be provided at each end of the power supply cable.

INSTALLATION

This range hood series can be:

- Installed under the cabinet.
- or
- Installed on the wall without a cabinet.

1a. Installing the Range Hood Under the Cabinet

- For installing under the cabinet with recessed bottom, attach a 4" wide wood filler strip (not provided) on each side.

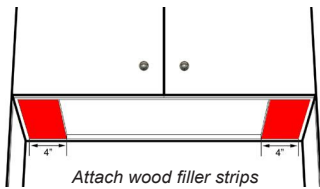

- Use a stud finder to locate and mark 2 studs inside the wall.

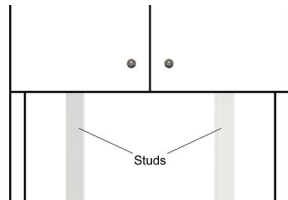

- Make 2 cutouts on the top and bottom of the cabinet that align with the outlet of the top vent on the Hood. The diameter of the cutout should be slightly larger than the diameter of the duct.

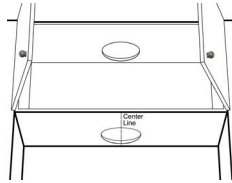
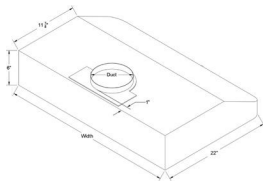

* For Round Vent Out Only

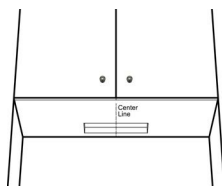
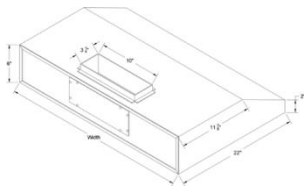

* For Rectangular Vent Out Only

The following steps require 2 or more people:

- Draw the power cord through the bottom cutout and align the range hood beneath the cabinet so that the exhaust on the Hood and the cutout are in line.
- Raise and screw the top of the Hood to the bottom of the cabinet through the knockout holes shown below:



- Tighten all screws until the range hood is securely mounted to the bottom of the cabinet.

Make sure the range hood is securely mounted before releasing.

- For a more secure installation, install additional screws into the pre-drilled holes on the backplate of the range hood to secure it to the studs or lumbers. If the pre-drilled holes don't align with the studs or lumbers, drill new holes on the backplate instead.

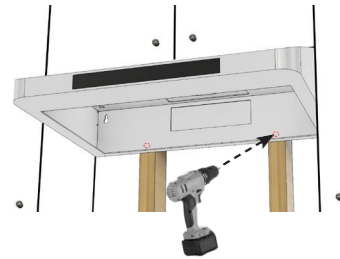

1b. Installing the Range Hood on the Wall without a Cabinet

- Remove the Baffle Filters from the Hood.
- Temporarily install the Mounting Bracket to the Hood Body on both sides.
- Take measurements of "A" and "B" as shown below.

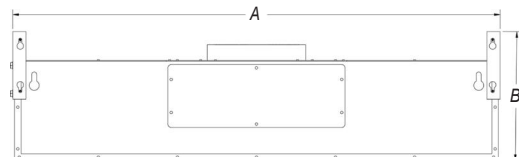

INSTALLATION

- Determine the location to install the Hood.
- Use a stud finder to locate and mark 2 studs within the installation area.
- Align and securely install the Brackets to the studs. Use an extender for the Bracket if the Bracket couldn't align with the stud.

The following steps require 2 or more people:

- Raise the Hood between the Brackets and align the side holes with the ones on the Brackets. Use the included screws to securely mount the Hood to the Brackets. If the Brackets are installed horizontally, drill new holes on the Hood Body instead.
- Install additional screws into the pre-drilled holes on the backplate of the range hood to secure it to the studs or lumbers. If the pre-drilled holes don't align with the studs or lumbers, drill new holes on the backplate instead.



2. Connecting the Vent System

- Use 6" round or 3-1/4 x 10" rectangular metal duct (or semi-rigid aluminum duct, follow the local building codes) to connect the exhaust on the Hood to the duct-work above.
- Use aluminum foil tape or duct tape to seal all connections.

3. Electrical Connection

WARNING: Electrical Shock Hazard. Disconnect power before servicing.

- In case of a direct connection to the house wiring is preferred, do the following:
 - Disconnect the power.
 - Cut off the plug from the power cord.
 - Connect the wires from the power cord to the wires from the house wiring using UL listed

wire connectors.

- Store the excess wires in the wiring box.
- Reconnect the power.

4. Installing the Baffle Filters

- Peel off the protective film from the baffle filters if there's any.
- Align the baffle filter's bottom pins to the holes on the hood. (*Step 1*)
- Pull and hold the latch. The top pins of the baffle filter will retract into the filter while the latch is pulled. (*Step 2*)

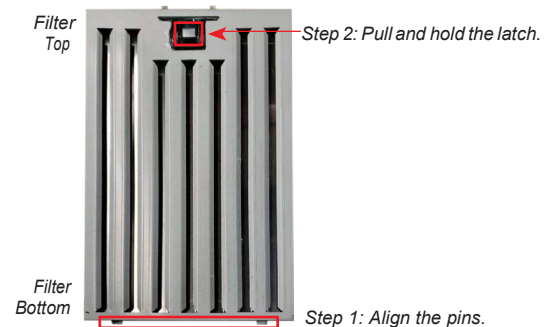

- Keep pulling and holding the latch and push the top end of the baffle filter upwards till it reaches the hood.
- Release the latch to lock the baffle filter in place.
- Repeat these steps to install the rest of the baffle filters.

Note

- *Make sure all baffle filters are securely locked and won't come off.*
- *These Baffle Filters collect the oil/grease while you cook. There's no need to install other types of filters.*
- *Clean the Baffle Filters every 2 to 3 months regularly. Follow the cleaning guide in Page 10.*

5. Completing the Installation

Turn power ON in the control panel. Check all lights and fan operations.

RANGE HOOD USE

Range Hood Control Panel

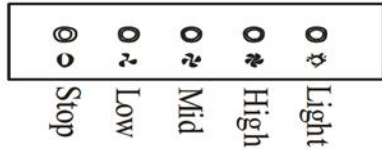

- Push stop button, and the motor will stop
- Push the Low button, the buzzer will buzz once and the motor will run at low speed.
- Push the Mid button, the buzzer will buzz once and the motor will run at mid speed.
- Push the High button, the buzzer will buzz once and the motor will run at high speed.
- Push the light button and two lights will on. Push it again and the light will turn off.

WARNING

Read all instructions and warnings before using the hood.

- DO NOT use the hood when there are no safety grills and filters.
- NEVER dispose cigarette ashes, ignitable substances, or any foreign objects into blowers.
- NEVER leave the cooking appliances unattended. When frying, the oil in the pan can easily overheat and catch on fire. The risk of self-combustion is higher when the oil has been used several times.
- NEVER cook on “open” flames under the range hood. Check deep-fryers during use: Superheated oil may be flammable.

RANGE HOOD CARE

Cleaning

WARNING

- To reduce the risk of electrical shock, DO NOT clean the hood while it's operating.
- Never put your hands into the area housing the fan when the fan is operating.

Cleaning the Exterior Surfaces:

IMPORTANT

To avoid damage to the exterior surfaces:

- DO NOT use corrosive or abrasive detergent.
- DONOT use steel wool, scoring pad or steel brushes. Use a paper towel or soft cloth or nonabrasive sponge instead.
- DO NOT use salt solutions, disinfectants, bleaches or cleaning compound that contains harmful chemicals.

Cleaning Method:

- Noncorrosive or nonabrasive liquid detergent soap or all-purpose liquid cleanser.
- Wipe the surfaces with a damp paper towel or soft cloth or nonabrasive sponge.
- Rinse with clean water.
- Wipe dry with dry towel or cloth.

Note

- The nonabrasive stainless steel polisher can be applied when done cleaning to retain the stainless luster and grain.
- Always follow the instruction of the polisher.

Cleaning the Stainless Steel Baffle Filters:

- Pull the spring release handle and remove the filter by pulling it down.
- Wash the filters in the dishwasher, or soak it into hot or warm water with dish detergent for half an hour, then wipe the filter clean. Repeat these steps until there's no oil residue remains.
- Let the filters dry thoroughly.
- Make sure the spring release handle is toward the

front, align and insert the filter.

- Pull the spring release handle and push the filter into position.
- Release the handle.
- Repeat the steps for the remaining filters.

Replacing the Filters

- Replace the baffle filters immediately should they become worn out due to aging or prolonged usage.

Replacing the LED Lamps

WARNING

Electrical Shock Hazard

Disconnect power before servicing

Wear gloves to protect against sharp edges

- This range hood uses 120V LED. (Model No.: GU10.)
- Unplug the range hood, or turn off the breaker.
- Press on the rim of the Lamp and twist counter-clockwise to unlock the Lamp.



- Pull out the defective Lamp. Use a flathead screwdriver if needed.
- Align and put the new Lamp back into position.

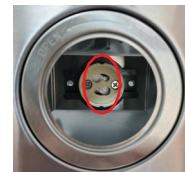

- Press on the rim of the new Lamp and twist clockwise to lock the Lamp in position.
- Plug in the range hood, or turn on the breaker.
- Check if the new Lamp is working properly.

RANGE HOOD TROUBLESHOOTING

Before Calling for Service

Issue	Possible Cause / Solution
The range hood doesn't turn on	<ul style="list-style-type: none"> • Check if the range hood is plugged in. Make sure that all power is turned on, the fuse isn't blown and all electrical wirings are properly connected.
The range hood turns on but the LED light doesn't	<ul style="list-style-type: none"> • Replace the defective LED assembly. Refer to range hood care section for instructions.
The range hood vibrates when the blower is on fan.	<ul style="list-style-type: none"> • Check and tighten the mounting screws to secure the hood to the cabinet or wall properly.
The blower or fan seems weak	<ul style="list-style-type: none"> • Check that the duct size used is at least 6" or 3-1/4 x 10". Range hood will not function efficiently with insufficient duct size. For example: 6" duct over 7" top vent and not sealed properly. • Check if the duct is clogged or the damper (half-circular flapper) is not installed correctly or opening properly. A tight mesh on a side wall cap might also cause restriction to the air flow.
The lights work but the blower is not spinning at all or is rattling	<ul style="list-style-type: none"> • The blower might be jammed or scraping the bottom due to shipping damage. • Disconnect the power cord, remove the fan grill and the fan blade, might see the fan blade or/and motor is not in the proper position (offset from the center). Try to fix/adjust it or please contact us immediately.
The hood is not venting out properly	<ul style="list-style-type: none"> • Make sure the distance between the stove top and the bottom of the hood is within recommended 24" and 30" in distance. *Due to different ceiling height configurations, the recommended height may not be applicable. • Reduce the number of elbows and length of duct work. Check if all joints are properly connected, taped and sealed. • Make sure the power is on high speed for heavy cooking.

WARRANTY

This product is warranted for a limited period of three years. Parts, begins from the date of purchase.

This limited warranty is applied to the original retail purchaser and valid only for products purchased for home use in the continental United States of America.

This limited warranty is non-transferable and does not extend to the subsequent owners of this product.

Any applicable implied warranties, including the warranty of merchantability, are limited in duration to a period of express warranty as provided herein beginning with the date of original purchase at retail and, no warranties, whether express or implied, shall apply to this product thereafter.

In the event of the product fail to work properly due to a defect in manufacturing materials or workmanship under normal home use, during the warranty period mentioned above, subject to the conditions and limitations set forth below, Empava will, at our options, either repair or replace any part of our products proven defective by reason of improper materials or workmanship:

- Proof of original retail purchase is required to receive warranty service within the limited warranty period.
- Repair parts or replacement products will be provided by Empava, free of charge, on an exchange basis, and will be either new or reconditioned.

This Limited Warranty Does Not Cover:

- Consumable parts such as light bulbs, stainless steel baffle filters.
- The natural wear of finish, and wear due to improper maintenance, use of corrosive and abrasive cleaning products, pads, and oven cleaner products.
- Chips, dents or cracks on the product caused by transportation and handling.
- Damage of product caused by accidents, pests and vermin, lightning, wind, fire, floods or acts of God.
- Damage of product caused by unauthorized modification or alteration, or if it is used for other

than the intended purpose, or any water leakage where the unit was not installed properly.

- Damage of product caused by incorrect electrical wiring, commercial or industrial use, or use of any cleaning products not recommended in this manual.
- Damage of product due to product misuse, abuse, improper installation, unauthorized repair or maintenance.
- Any loss of properties or any costs associated with removing, servicing, installing, or determining the source of problems with our products.

To Receive Warranty Service:

- Contact the seller or distributor from which you purchase the product. Please confirm the terms of your dealer's or distributor's policies prior to contacting. Or contact us directly.
- Provide the product identification information, such as model number and lot number, and proof of original purchase.
- Describe the issue you are experiencing in detail.

Product Support and Additional Information:

If you need assistance using your product or you would like to start the warranty service:

- Contact us at 1-888-682-8882, between 9 AM and 5 PM, Monday - Friday, Pacific Time.
Or
- Contact us at <https://www.empava.com/contact-us>.

