

DIATONE® Taycan C25 MK2机架组装示意图

Taycan C25 MK2 Frame Assemble Diagram

更少的零件意味着更容易安装，同时提供封闭涵道和开放式涵道，你可以使用封闭涵道以获得更多推力，或者使用开放涵道使飞行更加灵活。我们修正了第一版中的一些问题，更轻的重量、更坚固的材料以及更换电机不再需要拆解护圈等等。新的版本使用一体式的机架以获得较高强度的同时减少重量，也获得更高的FC安装空间，你甚至可以堆栈三层设备。当然Taycan C25 MK2的Vista是后置的，拥有专用的安装位置，并且支持快速安装卡槽。框架采用前后对称设计，所以你可以在尾部增加一个高清摄像的机位，你将获得全新的视角，拥有愉快的拍摄体验，从Taycan开始……

Fewer parts, easier install. Taycan C25 MK2 adds a closed duct for more pushers and an open duct for a more flexible flying experience. Compared with the first edition, Taycan C25 MK2 is lighter in weight, sturdy in material, and no longer disassemble the guard ring while replacing the motor.

It uses an integrated framework to reach a more sturdy body, lighter weight, larger installation space so that three layers of equipment can be stacked.

The VISTA of the Taycan C25 MK2 is rear-mounted, has a dedicated installation position, and supports quick installation of the card slot. The frame adopts a front and rear symmetrical design, you can add a high-definition camera position at the rear and have a new perspective. Starting a pleasant shooting experience, from Taycan...

产品规格















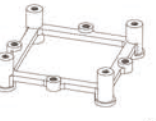



Product Specifications

机架类型: 涵道	对角轴距: 111.5mm	机架净重: 55g	上板厚度: 1mm
卡簧孔径: \varnothing 4.5mm	设备层高: 16mm	支持最大桨叶: 2.5 inch	对角孔距: 9mm/12mm(M2)
推荐电池: 4S (650-850 mAh)	推荐电机: 12-14系列电机	飞控孔距: 25 \times 25mm (M2)	摄像头间距: 19mm/20mm

Frame Shape: Duct	Motor to Motor: 111.5mm	Frame Net Weight: 55g	Top Plate Thickness: 1mm
Bore Diameter of Snap Ring: \varnothing 4.5mm	Max Stack Height: 16mm	Supported Prop Size: 2.5 inch	Motor Hole Distance: 9mm/12mm(M2)
Recommended Lipo: 4S(650-850mAh)	Motor Size: 12-14 Series motor	FC Stack Mount: 25 \times 25mm (M2)	Camera Spacing: 19mm/20mm

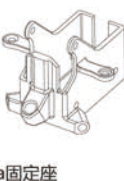
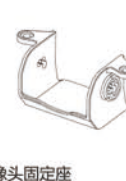
配件清单

Parts list

A1  C25 MK2开放式涵道 C25 MK2 Open Duct	B1  电机保护板 Props protection plate	B2  前后板 Front and Rear plate	B3  中板 Medium plate	B4  Vista 专用后板 Vista Dedicated Rear Plate	C1  25.5AIO飞控转20mm底座/45° 25.5 to 20mm Adaptor /45°
C2  M2 \times 5 \times 0.5铁垫片 M2 \times 5 \times 0.5mm iron gasket	C3  M2 螺母 M2 Nut	C4  M2 \times 8mm滚花铝柱 M2 \times 8mm Al Standoff	C5  M2 \times 4mm内六角螺丝 M2 \times 4mm Hex Screw	C6  M2 \times 5mm内六角螺丝 M2 \times 5mm Hex Screw	C7  M2 \times 7mm内六角螺丝 M2 \times 7mm Hex Screw
C8  M2 \times 11mm内六角螺丝 M2 \times 11mm Hex Screw	C9  M2 \times 16mm内六角螺丝 M2 \times 16mm Hex Screw	C10  M3 \times 5mm沉头内六角螺丝 M3 \times 5mm Sunken Socket Head Cap Screw	D1  Vista固定座 Vista Mount	D2  摄像头固定座 Camera Mount	D3  SMA天线固定件 SMA Antenna fixing seat
D4  减震相机座 (8mm) Camera damping mount	D5  USB固定座 USB Mounting	E1  电池防滑垫(黑色) Battery anti-slip Pad(Black)			

安装步骤

Assembly Guide

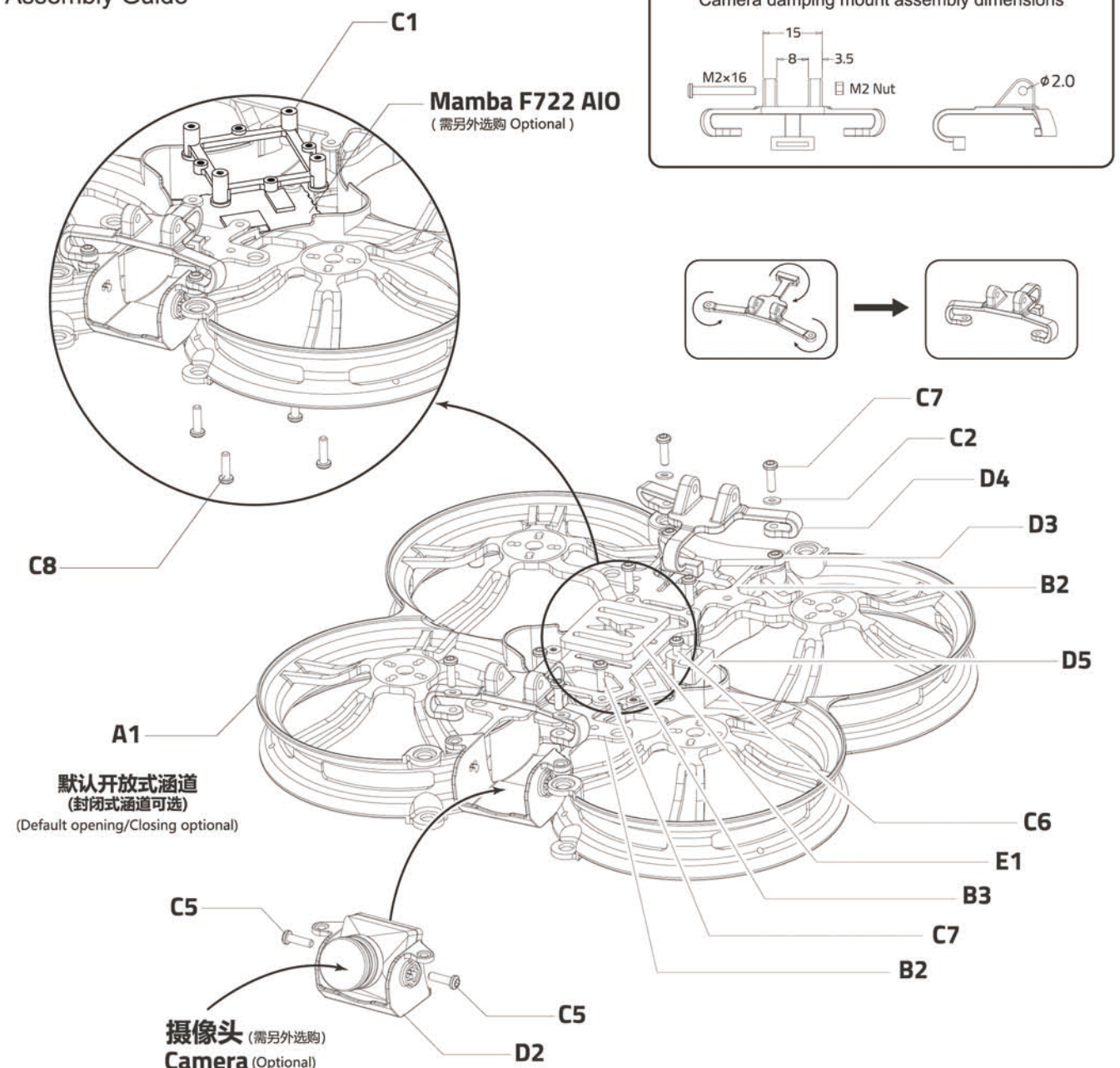

Vista 安装

Vista installation

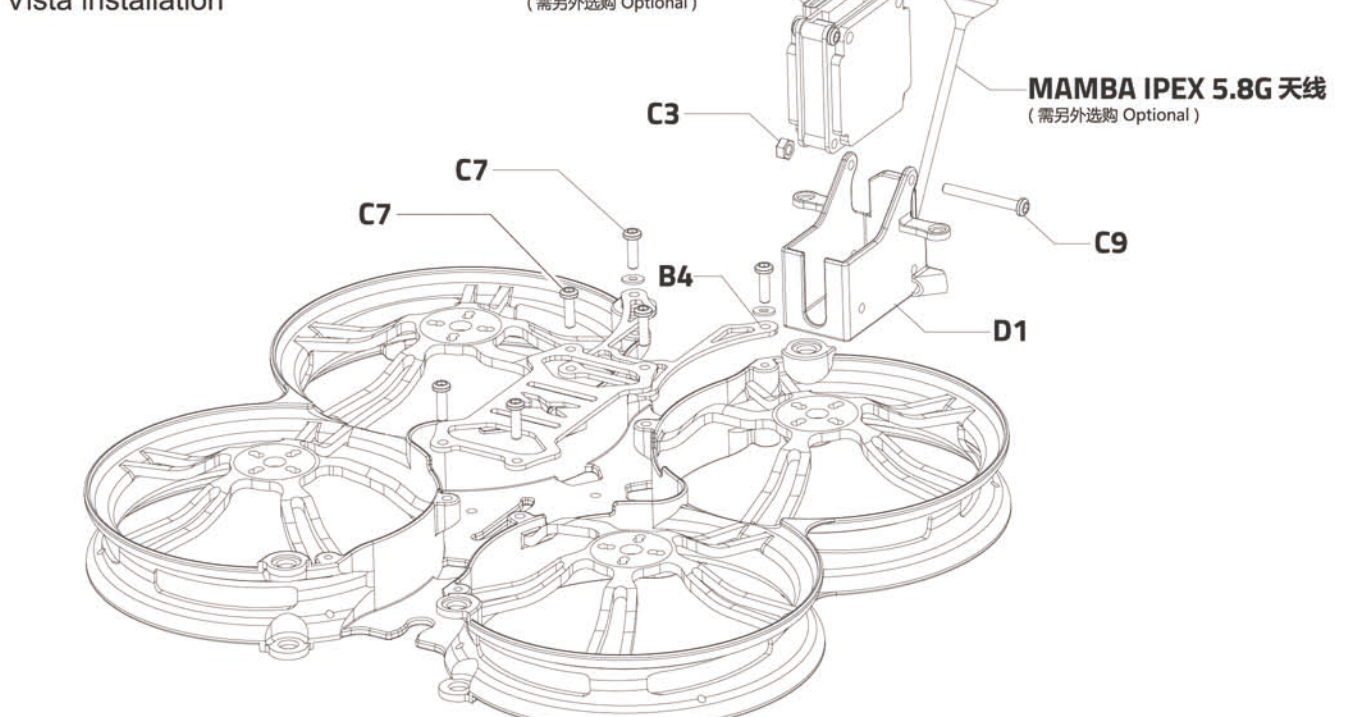

电机护板安装

Installation of props guard plate

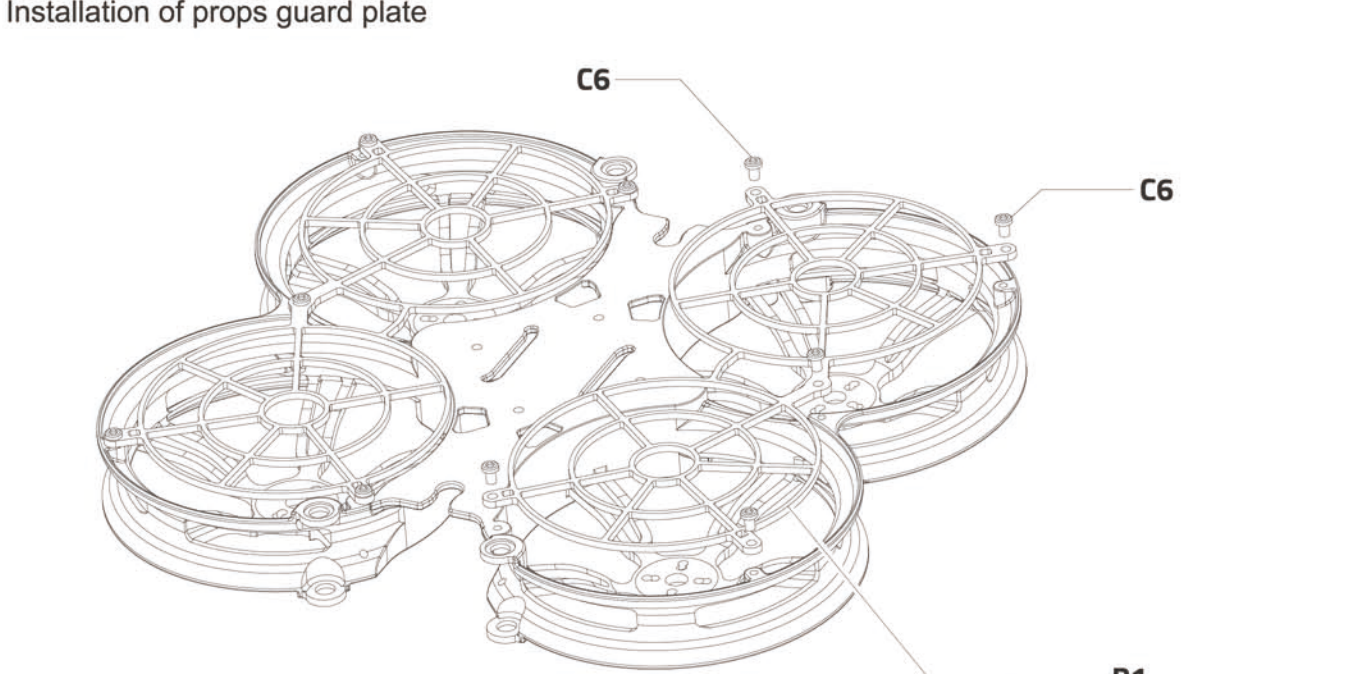

更详细的信息，可通过访问DIATONE官网获得

For more information, please refer to the Diatone official website

DIATONE®

We provide outstanding service since 2012

Manufacturer : Diatone Innovation Designed by Snico.

Tel : (+86) 0769-82100057 Web : www.diatone.us

Address : Bajiyai Technology Park A-3, Yantian, Fenggang, Dongguan, Guangdong, China