

DIATONE[®] ROMA F6 机架组装示意图

ROMA F6 Frame Assemble Diagram

Roma F6 作为F系列6inch紧凑型设计，较5inch在动力输出及续航时间上有所提升。兼容DJI FPV高清图传及普通模拟图传，预留了GPS模块安装位，机头为钛钢表面抛光处理，新配色的全系列注塑保护件，提升颜值及细节的同时，更适合入门玩家对产品的保护。Gopro可调角度座，极大方便用户的使用体验。紧凑型低重心设计，将会获得更好的手感及飞行性能。

Roma F6 is a 6-inch compact design of the F series, which has improved power output and battery life compared to the 5inch. Compatible with DJI FPV HD image transmission and ordinary analog image transmission.

GPS module installation position is reserved.

The camera protection head is polished with titanium steel surface.

The new colorful injection protection parts enhance the appearance and details, and are more suitable for beginner players.

The Gopro adjustable angle seat greatly facilitates the user experience. The compact low center of gravity design will get better hand feeling and flight performance.











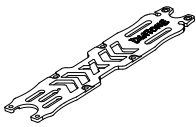
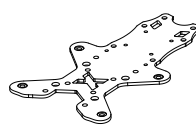
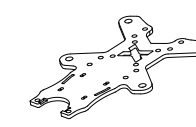
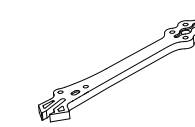
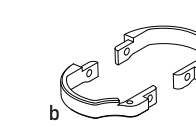
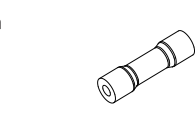
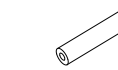







产品规格







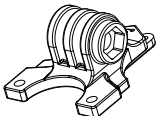
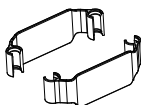

Product Specifications

机架类型: H型	对角轴距: 260mm	机架净重: 190g	上板厚度: 2.5mm
中板厚度: 2mm	底板厚度: 3.5mm	机臂厚度: 6mm	机臂宽度: 11~18mm
卡簧孔径: \varnothing 5mm	设备层高: 23mm	支持最大桨叶: 6 inch	摄像头间距: 19mm/20mm
推荐电池: 4S~6S	电机安装孔距: 16mm(M3)	推荐电机: 23系列电机	飞控孔距: 20×20(M2/M3)/30.5×30.5 (M3)
Frame Shape: Type H	Motor to Motor: 260mm	Frame Net Weight: 190g	Top Plate Thickness: 2.5mm
Medium Plate Thickness: 2mm	Bottom Plate Thickness: 3.5mm	Arm Thickness: 6mm	Arm Width: 11~18mm
Motor circlip: \varnothing 5mm	Max Stack Height: 23mm	Supported Prop Size: 6 inch	Camera Spacing: 19mm/20mm
Recommended Lipo: 4S-6S	Motor Mounting: 16×16mm(M3)	Recommended Motor: 23 Series	FC Stack Mount: 20×20mm(M2)/30.5×30.5mm(M3)

配件清单

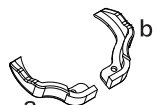
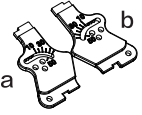
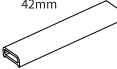
Parts list

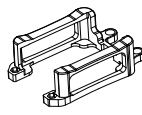
A1  上板 Top Plate	A2  中板 Medium plate	A3  底板 Bottom plate	A4  机臂 Arm	B1  机头金属件 Drone head metal parts	B2  M3×23mm台阶铝柱 M3×23mm AI Standoff
B3  M3×23mm铝柱 M3×23 AI Standoff	B4  M2×19mm铝柱 M2×19mm AI Standoff	C1  M2×4mm 内六角螺丝 M2×5mm Hex screw	C2  M2×6mm 内六角螺丝 M2×6mm Hex screw	C3  M2×11mm 内六角螺丝 M2×11mm Hex screw	C4  M3×5mm 内六角螺丝 M3×5mm Hex screw
C5  M3×6mm 内六角螺丝 M3×6mm Hex screw	C6  M3×9mm 内六角螺丝 M3×9mm Hex screw	C7  M3×11mm 内六角螺丝 M3×11mm Hex screw	C8  M3×12mm 内六角螺丝 M3×12mm Hex screw	C9  M3×16mm 内六角螺丝 M3×16mm Hex screw	C10  M3×30mm 内六角螺丝 M3×30mm Hex screw
C11  M5×20mm 内六角螺丝 M5×20mm Hex screw	C12  M3×5mm 沉头内六角螺丝 M3×5 Sunken Socket Head Cap Screw	C13  M5自紧螺母 M5 Self tightening nut	C14  M3×5×0.5mm铁垫片 M3×5×0.5mm Iron gasket	D1  M2螺母 M2 Nut	D2  M3螺母 M3 Nut
×1	×2	×1	×8	×4	×8

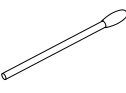
- | | | | | | |
|---|---|---|---|---|---|
| D3 | D4 | D5 | D6 | D7 | D8 |
|  |  |  |  |  |  |
| GoPro可调座
GoPro adjustable mount | 飞控保护侧板
FC Guard Plate | 脚垫
Foot pad | 电源线固定件
Power cord fixing | 前进风侧板
Front airflow side panel | 机头保护件
Camera protector |
| ×1 | ×2 | ×4 | ×1 | ×1 | ×1 |
| D9 | D10 | E1 | E2 | E3 | E4 |
|  |  |  |  |  |  |
| 镜头侧板
Camera plate | 电机线保护
Motor wire cover | M-22 GPS/TBS/2.4G固定件
M-22 GPS/TBS/2.4G 3D-Printed out | GPS/TBS/2.4G固定座
GPS/TBS/2.4G 3D-Printed out | DJI天空端固定座
DJI AIR Unit bracket | DJI双天线固定座
DJI dual antenna mount |
| ×1 | ×4 | ×1 | ×1 | ×1 | ×1 |
| | 42mm | | | | |
| F1 | F2 | | | | |
|  |  | | | | |
| 电池防滑垫
Lipo anti-slip pad | 2.4G天线保护
2.4G Antenna protector | | | | |
| ×1 | ×2 | | | | |

安装步骤 Installation procedure

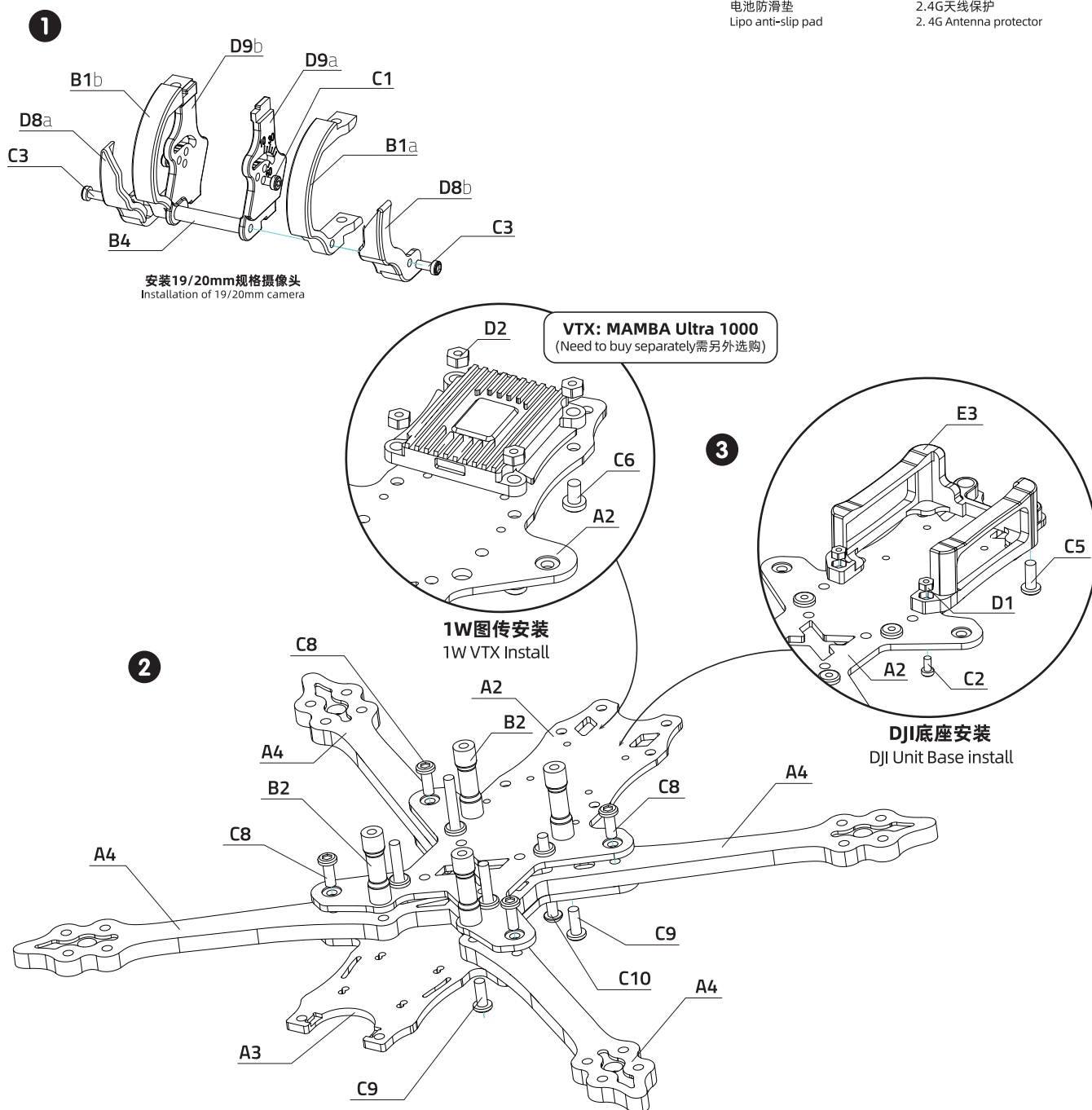

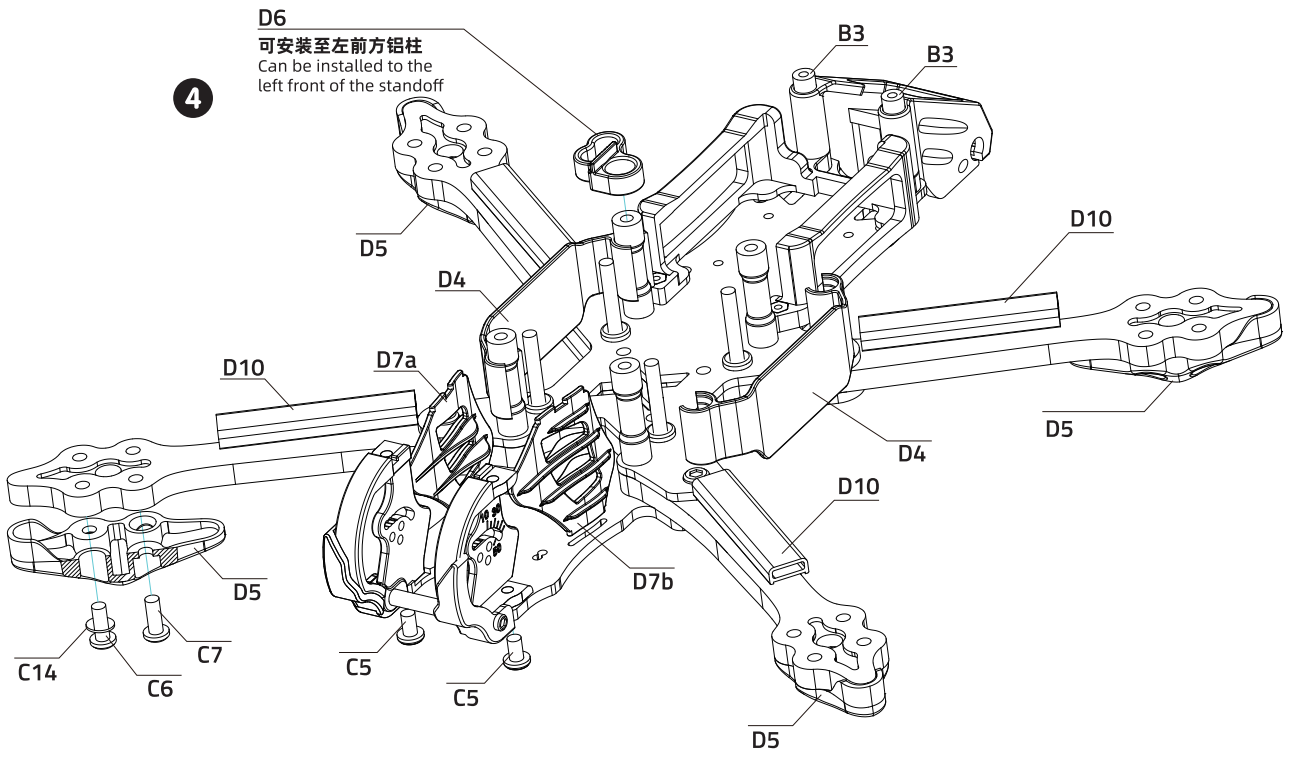

天线安装方式一:
Antenna installation Way1:

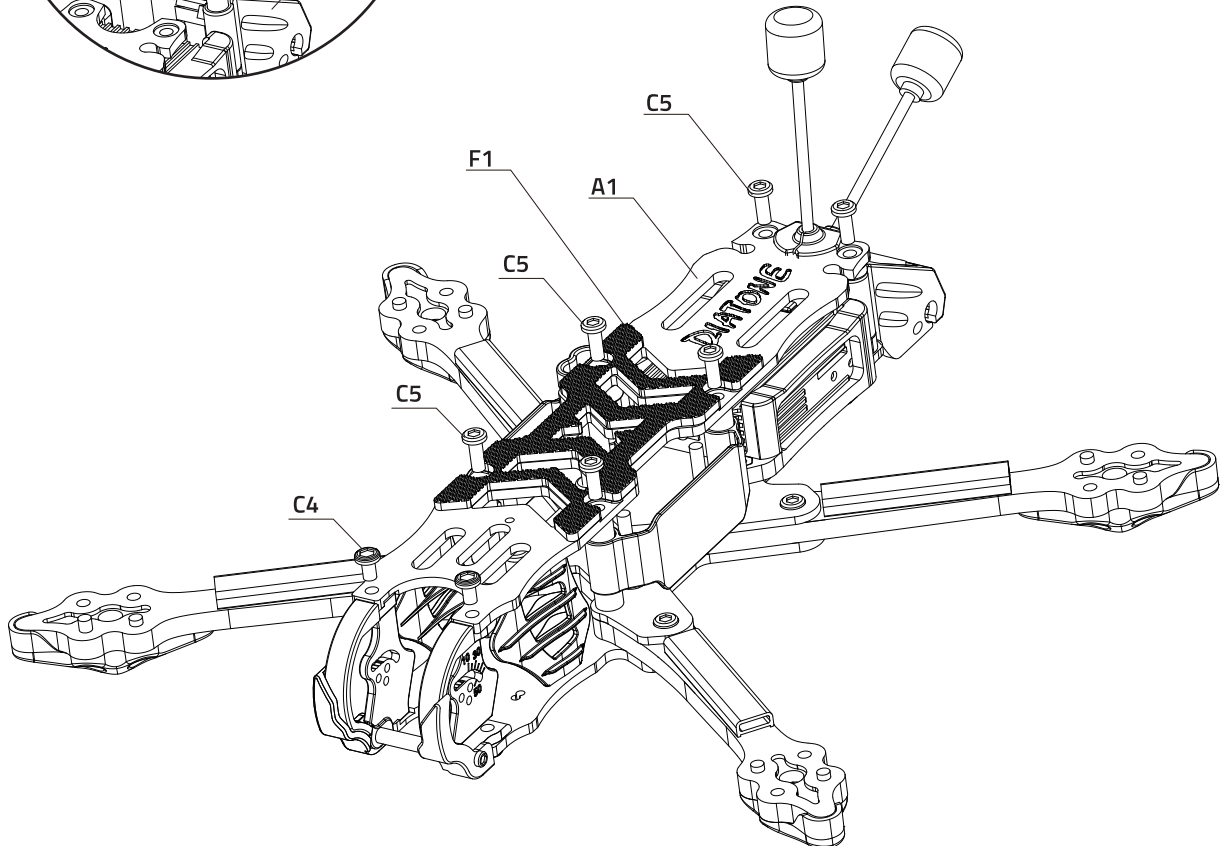
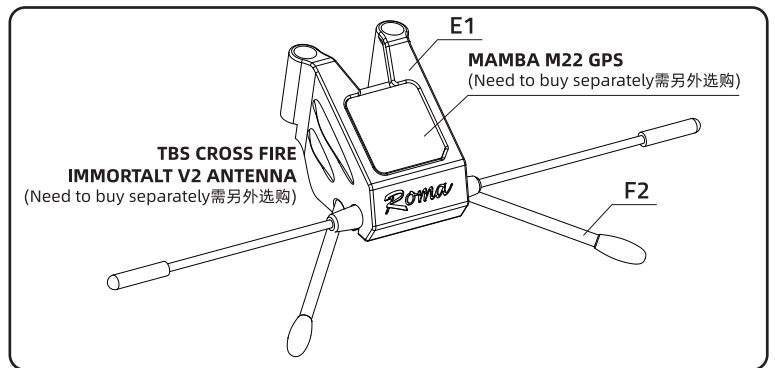
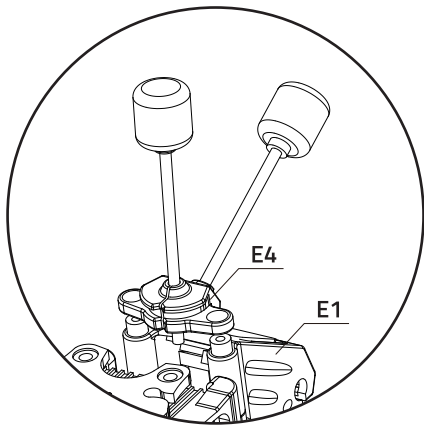

天线安装方式二:
Antenna installation Way2:

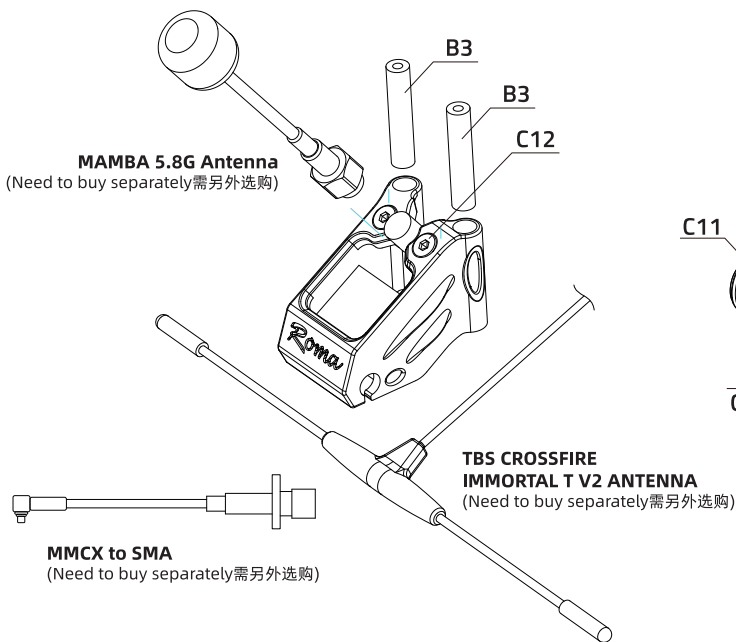

Gopro可调座安装:
GoPro Adjustable Base Installation:

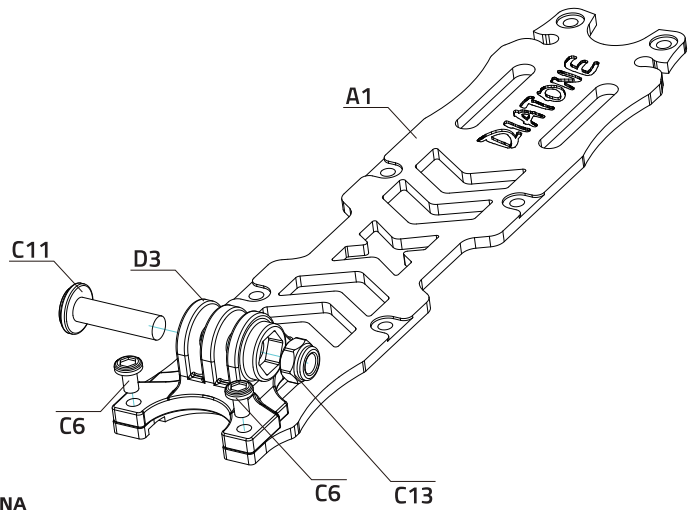

电池固定方式
Battery fixing way

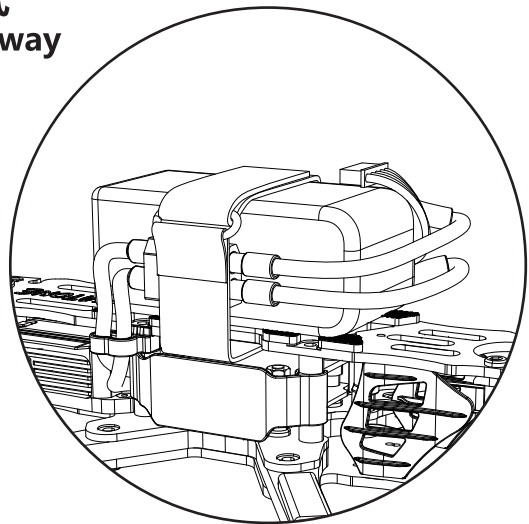
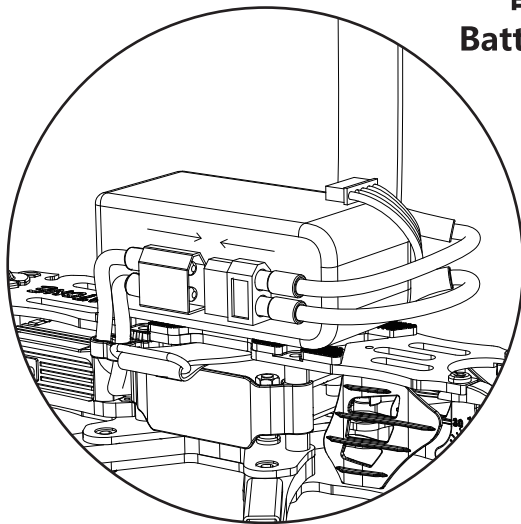

更详细的信息, 可通过访问DIATONE官网获得
For more information, please refer to the Diatone official website

DIATONE®

We provide outstanding service since 2012

Manufacturer : Diatone

Email : service.support@diatone.hk

Tel : (+86) 0769—82100057

Web : www.diatone.us

Address : Baijiayi Technology Park A-3, Yantian, Fenggang, Dongguan, Guangdong, China