

# WINE & BEVERAGE COOLER

## USER MANUAL

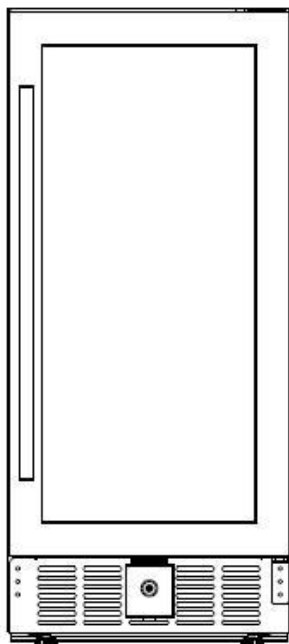

Model: JC-85B

To ensure proper use of this appliance and your safety, please read the following instructions completely before operating.

---

# TABLE OF CONTENTS

---

Product Feature .....	2
Before Putting Into Use .....	2
Tips For Energy Saving.....	2
Important Safety Instructions.....	2
Name Of The Parts.....	6
Specifications.....	7
How To Operate	
Storing The Wine Bottle Or Can.....	7
Starting And Running Your Unit.....	8
Operation Button Panel.....	8
How to Clean.....	9
How to Install.....	9
Care And Maintenance.....	10
Troubleshooting Guide	
What To Do.....	11

---

## PRODUCT FEATURE

---

1. Transparent glass door, luxury out-looking, elegant design, easy operating.
2. Envelope with attracting black color.
3. Low noise, high energy efficiency, updated quick cooling system.
4. Plastic enveloped or chrome-plated wire rack shelves, sanitation, convenience.
5. Touch-button control panel for operation.

## BEFORE PUTTING INTO USE

---

- Before connecting the appliance to the power supply, let the unit stand upright for 4 hours, which will reduce the possibility of the cooling system malfunctioning due to improper handling.
- Clean your unit thoroughly before putting into use. (See “How To Clean”)
- Use the “parts diagram” on page 6 to ensure proper positioning of internal components.

## TIPS FOR ENERGY SAVINGS

---

- Keep the unit doors closed as much as possible, particularly in warm / humid conditions.
- Maintain adequate ventilation around the back and sides of the unit.
- Cool the warm wine bottle to room temperature before placing in the unit.
- Do not obstruct the hot air outlet frame in front.

## IMPORTANT SAFETY INSTRUCTIONS

---

**Before you use your refrigerator, basic safety precaution must be followed in order to reduce the risk of fire, electrical shock, and/or injury to person or property. Before you use your refrigerator, please read this owner’s manual carefully and observe the following safety tips.**

Use this appliance only for its intended purpose as described in this owner’s manual.

**-WARNING:** This appliance is intended to be used in household and

---

similar applications such as

- staff kitchen areas in shops, offices and other working environments;
- farm houses and by clients in hotels, motels and other residential type environments;
- bed and breakfast type environments;
- catering and similar non-retail applications.

- The appliance must be correctly installed and connected to the power supply in accordance with the installation instructions before it is used. (See: “HOW TO INSTALL”)
- The main power supply must be properly grounded.
- This refrigerator must be positioned so that the plug is accessible. Never unplug your unit by often pulling the power cord. Always grasp the plug firmly and pull it straight out from the socket.
- Do not use an extension cord as this can negatively affect the performance of the unit. If you must use an extension cord, use 18AWG minimum size and rated no less than 1875 watts.
- When transporting the refrigerator, keep the unit in the upright position. Do not tilt the appliance more than 45° or place it in an inverted position. Do not tip over.
- Do not touch the cooled surfaces while the appliance is operating, especially not with wet hands, because the skin may stick to the cold surfaces.
- It is recommended that the refrigerator is positioned away from any combustible sources such as gas, petrol, alcohol, lacquer and banana oil, etc. The aforementioned objects should not be stored in the refrigerator under any circumstances.
- If the unit fails to cool properly, please dispose of spoiled food as needed.

- 
- Unplug your unit before cleaning or making any repairs.

**NOTE:** *If for any reason this product requires service, we strongly recommend that a certified technician perform the service. Repairs made by non-qualified personnel will void the warranty.*

- Do not defrost the appliance with other electric devices (hair dryer etc.) and never scrape the ice or frost layer with sharp tools. Warning: Do not damage the refrigerant circuit.
- The rating plate is inside the appliance or outside on the rear or side wall.
- This appliance is not intended for use by persons (including children) with reduced physical, sensory or mental capabilities, or lack of experience and knowledge, unless they have been given supervision or instruction concerning use of the appliance by a person responsible for their safety. Children should be supervised to ensure that they do not play with the appliance.
- Do not run cord over carpeting or other heat insulators. Do not cover the cord. Keep cord away from traffic areas, and do not submerge it in water. If the supply cord is damaged, it must be replaced by the manufacturer or its service agent or a similarly qualified person in order to avoid a hazard. Immediately repair or replace all electric cords that have become frayed or otherwise damaged. Do not use a cord that shows cracks or abrasion damage along its length, the plug or the connector end.
- **WARNING:** Keep the ventilation in the appliance housing or built-in structure open and clear of obstruction.
- **WARNING:** Do not use mechanical device or other means to accelerate the defrosting process, other than those recommended by the manufacturer.
- **WARNING:** Do not damage the refrigerant circuit.
- **WARNING:** Do not use electrical appliances inside the food storage compartments of the appliance, unless they are of the type recommended by the manufacturer.

- 
- Do not operate your refrigerator in the presence of explosive fumes.
  - **WARNING**--Do not use the flame or catch the fire near the unit.
  - Please dispose of the appliance according to local regulations as the appliance contains flammable gas and refrigerant.
  - Follow local regulations regarding disposal of the appliance due to flammable refrigerant and gas. All refrigeration products contain refrigerants, which under the guidelines of federal law must be removed before disposal. It is the consumer's responsibility to comply with federal and local regulations when disposing of this product.



## **Safety instruction for refrigerant**

- **DANGER**—Risk of Fire or Explosion. **FLAMMABLE REFRIGERANT Used. Do Not Use Mechanical Device To Defrost Refrigerator. Do Not Puncture Refrigerant Tubing**
- **DANGER**—Risk of Fire or Explosion. **FLAMMABLE REFRIGERANT Used. To Be Repaired Only By Trained Service Personnel. Do Not Puncture Refrigerant Tubing.**
- **CAUTION**—Risk of Fire or Explosion. **FLAMMABLE REFRIGERANT Used. Consult Repair Manual/Owner's Guide Before Attempting To Service This Product. All Safety Precautions Must be Followed.**
- **CAUTION** — Risk of Fire or Explosion. **Dispose Of Property In Accordance With Federal Or Local Regulations. Flammable Refrigerant Used.**
- **CAUTION** — Risk Of Fire Or Explosion. **Due To Puncture Of Refrigerant Tubing; Follow Handling Instructions Carefully. FLAMMABLE REFRIGERANT Used.**

---

# NAME OF THE PARTS

Following figure also is for the wine cooler with left-opening door.

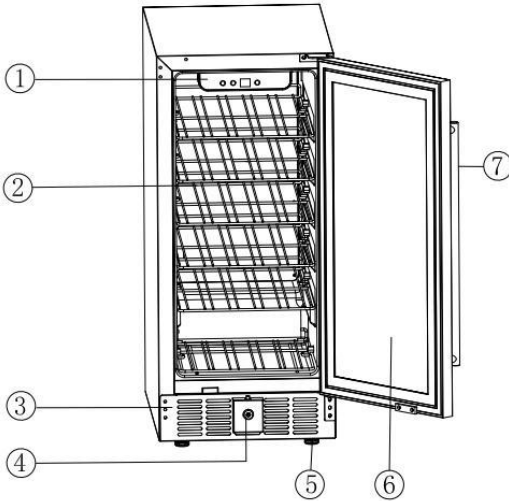

Model No.: **JC-85B**

(1) Operation Panel:



- (2) Removable Wine bottle or Can Shelf
- (3) Hot Air outlet frame
- (4) Door Lock (Optional)
- (5) Height Adjustable Feet
- (6) Glass Door
- (7) Door Handle (Need to assembled by yourself)

# SPECIFICATIONS

Product Description	Wine cooler, Beverage center		
Model No.	JC-85B		
Capacity	82 L/2.9 Cu.Ft.		
Electrical Rating	115V~/60Hz/0.9 A		
Refrigerant	R600a, 0.67 Oz/19 g		
Unit Dimensions	Width	Depth	Height
With Feet (Inches)	14.95" (380mm)	22.52"(572mm)	33.9 "(860mm)
Net Weight (Lbs)	63.93Lbs		

# HOW TO OPERATE

## Storing the Wine Bottle & Can

- Wines should be laid on the shelves in sealed containers to avoid leakage.
  - Do not overload.
  - Do not open the door unnecessarily or leave the door ajar.
  - Do not cover the shelf with any material such as aluminium foil as this will impede air circulation within the cabinet.
  - Do not store explosive substances such as aerosol cans with a flammable propellant in this appliance.
- ▶ Please place the wine bottles reference to following figure: (For maximum loading)

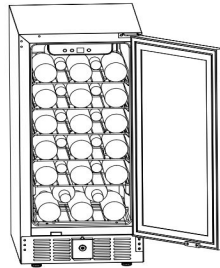

- ▶ For canned beverage or drink, please see the following figure: (For maximum loading)

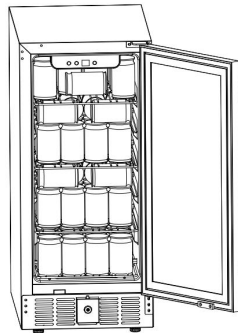



---

## Starting and Running the Unit

**Important:** If the unit is brought in from outside in the winter season, give it a few hours to warm up to room temperature before plugging it in.

And also after transportation and moving of the unit, please wait for a least 4 hours then to plug on the unit.



1. Remove the packaging material.
2. Clean the unit thoroughly. Wipe the outside with a soft dry cloth, the interior with a clean moist cloth.
3. Connect the power cord to a standard wall outlet, you will hear a beep, which is normal. And the display on the control panel will revert to actual internal temperature.
4. Do not put wines or beverages into the wine cooler within two hours after the power on.

## Operation Button Panel



There are three buttons and temperature display window on the control panel, let you operate your unit and reach your desired running way.

## Temperature Adjustment

Press two buttons “” & “” to adjust the temperature to your desired value. Each pressing, the temperature will change 1 Fahrenheit.

Setting Range: 36-61 Fahrenheit. The default setting is 39 Fahrenheit.

## Interior Light Control

The unit has a built-in LED light in the cooling compartment. When you open the glass door, the LED light will be totally on; again close the door, the LED

light will be off. And also this LED light is controlled by the light button “” on the control panel. Press this button, the LED light will change to half brightness, then after the glass door is closed, the LED light will be still on. And

if you press “” button again, the LED light will recover to normally total brightness, and it will be off when the glass door is closed. For maximum energy efficiency, please leave the light off when not viewing your collection.

**Note:** Wait 3-5 minutes before restarting if you unplug the refrigerator. The unit may

fail to operate properly if restarted too quickly.

## HOW TO CLEAN

**IMPORTANT:** Do not clean your unit with flammable fluids. The fumes can create a fire hazard or explosion.

**WARNING:** 1. Before maintenance or clean to the unit, be sure to unplug the unit first.

2. Prohibit to pour down the water or let the whole unit submerge in the water, or it will wet the inside electrical parts.

**Cleaners:** Never use harsh, abrasive cleaners, heavy-duty cleaners, or solvents on any surface.

**Exterior:** Wipe with damp, sudsy cloth, rinse and dry. For stubborn stains and for periodic waxing, use silicon wax.

**Refrigeration Section:** Wash shelves and other removable parts in warm sudsy water, rinse and dry. Wash interior with baking soda solution (3 tablespoons to 1 liter of water) or warm sudsy water, rinse and dry.

**Magnetic Door Seals:** Wash with warm sudsy water.

## HOW TO INSTALL

**This appliance can either stand alone or be built in. The front grille must not be obstructed.**

- Install the unit in a convenient location away from extreme heat and cold place. This unit should be far away from the heating source, such as stoves, heater, or radiators, and be prevented from direct sunlight. Allow sufficient clearance between the unit and sidewall so the door will open without obstruction.
- Place the unit on a level surface that will be strong enough to support the unit when it is fully loaded. Not recommended for carpeting or other soft / uneven surfaces. To level your fridge, adjust the front feet located at the bottom of the unit.
- For under-counter built-in installation, please following the following diagram, and leave the enough space for the unit.

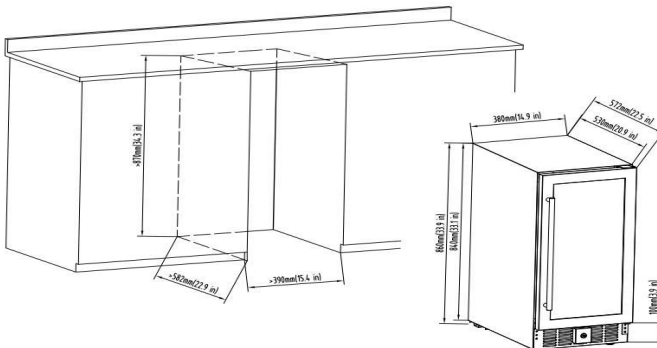

- 
- For free standing installation, suggest to allow 2 inches of space between the unit's side, rear and the wall. In addition, sufficient clearance (160°) should be maintained to allow the glass door to open properly and completely.

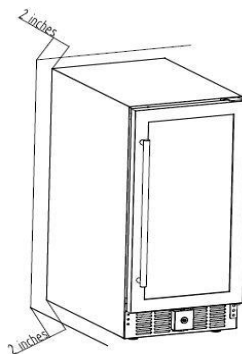

- The appliance must be correctly connected to the power supply, 115V/60Hz, certainly grounded.

The unit is not designed to be installed in an outside area such as a garage or a porch. Ambient temperatures of below 50°F or above 90°F will hinder the performance of the appliance.

## CARE AND MAINTENANCE

---

- ▶ The unit should be cleaned on a regular basis. (See: “HOW TO CLEAN”)
- ▶ It is necessary to have an adequate ventilation space around the unit in order to attain proper performance, dissipation of heat, maintain efficiency, and low power consumption. Clearance of minimum 2 inches should be maintained at the rear and sides of the unit. **And especially do not obstruct the front hot air outlet frame.** (See: “HOW TO INSTALL”)
- ▶ Do not modify the power cord under any circumstance to allow the unit to be plugged into a non-grounded outlet. To avoid heat damage to the power cord, please ensure that it does not come in proximity or in direct contact with the compressor of the unit.

---

▶ Please avoid installing the unit in a location where the appliance will come in contact with water or moisture to minimize rusting of metal parts.

▶ The unit should not be installed near any heat source or in a location where it will come in direct contact with the sunlight.

▶ The components, if need to be replaced, should be replaced with similar components, and should be replaced by the manufacturer or its service agent or a similarly qualified person in order to avoid a hazard and to minimize the risk of possible ignition and also to decrease the cooling performance due to incorrect parts or improper service.

## **TROUBLESHOOTING GUIDE**

---

### **WHAT TO DO ...**

#### **When the unit is not in use for a prolonged period:**

- Remove the plug from the outlet.
- Remove all contents from the unit.
- Dry the interior and leave the door open for a few days.

#### **When the unit does not work:**

- Check if there is a power failure.
- Check if the power plug is plugged into the power outlet.
- Check that the fuse has not blown in main supply circuit.

#### **When you wish to move the fridge:**

- Secure all movable parts and contents. (Package them separately if necessary.)
- Transport the fridge only in an upright position. In any other position you may damage the compressor.

Before calling service, please follow the checklist below.  
This may save you an expensive service call.

---

**If the unit seems too warm inside:**

- Check to see that the door is closing properly and the door seal is not damaged.
- Check that the interior circulation is not obstructed by having too many goods stored. (The fridge is overloaded)
- Did you store anything hot, without first cooling it to room temperature?
- Is there sufficient clearance around all sides and above the fridge?
- Do you set the temperature too high?

**When the condensate water overflows inside the unit and onto the floor:**

- Check that the drain pipe and the drain hose are not clogged.
- Check that the drain pan is housed properly.

**When condensation forms on the outside of the unit:**

- Condensation may form on the outside when the humidity level is high such as during a wet season. This is the same result as the condensation formed when chilled water is poured into a glass. It does not, therefore, indicate a failure, just wipe dry with a dry cloth.

**If the fridge starts making any unusual noises:**

- Is it wobbling? Re-level it and check if it now operates normally.
- Have any objects fallen behind the fridge? If so, remove them and check if operation is now normal.
- Are any containers inside the fridge vibrating or resonating? If so, rearrange them then check to see if operation has returned to normal.





Thank you for purchasing this product! If you have any questions about the product, such as missing parts, damaged products, product assembling, and operation, please contact us via **Amazon Message** or customer service number: **213-4467172** or **661-4358826**

### **IMPORTANT**

Please call our customer service department for any consulting:

**213-4467172**

**661-4358826**

(8:30am - 5:30pm P.S.T.)

DATED PROOF OF PURCHASE IS REQUIRED FOR WARRANTY SERVICE.

### **AVIS**

Veuillez appeler le service à la clientèle pour toutes questions au:

**213-4467172**

**661-4358826**

(8:30am - 5:30pm P.S.T.)

PREUVE D'ACHAT ORIGINALE REQUISE POUR SERVICE DE GARANTIE.

### **IMPORTANTE**

Sólo hay que llamar nuestro departamento de servicio al cliente en caso de tener preguntas o inquietudes:

**213-4467172**

**661-4358826**

(8:30am - 5:30pm P.S.T.)

SE REQUIERE PRUEBA DE COMPRA CON FECHA PARA SERVICIO BAJO GARANTÍA.

**Address : 9733 Topanga Canyon Blvd. APT310, Chatsworth, CA  
91311**

**Phone: 213-4467172 or 661-4358826**