

<b>物料编码</b>	109070203002003
<b>版次</b>	<b>v1</b>

**此页不要印刷，只作说明**

# **INSTRUCTION MANUAL**

## **DEHUMIDIFIER**

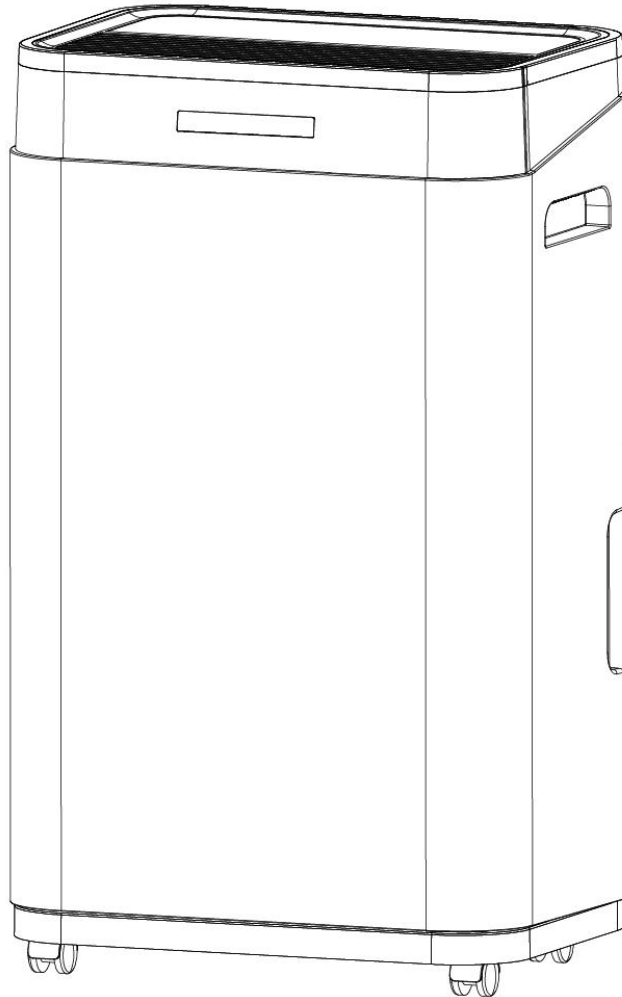

**Item NO:D4220B**  
**Applicable Model:OL20D-D030B**

**Please keep this manual carefully for further reference!**

**Thank you for selecting our dehumidifier. Be sure to read this manual carefully before using it. Any questions, please contact the professional service for help.**

## **1. BEFORE YOU BEGIN**

**Please read the operating instructions carefully before using your dehumidifier for the first time.**

### **1.1 PRODUCT DESCRIPTION**

The dehumidifier is used to remove excessive moisture from the air. The resulting reduction in relative humidity protects buildings and their contents from the adverse effects of excess humidity.

## **2. FOR YOUR SAFETY**

**Your safety is the most important thing we are concerned about!**



**Please read this manual carefully and fully understand it before operating your dehumidifier.**

### **2.1 OPERATIONAL PRECAUTIONS**

**WARNING-** to reduce the risk of fire, electric shock or injury to persons or property:

- If the supply cord is damaged, it must be replaced by the manufacturer, its service agent or similarly qualified persons in order to avoid a hazard.
- The appliance shall be disconnected from its power source during maintenance.
- Always operate the unit from a power source of equal voltage, frequency and rating as indicated on the product identification plate.
- Always use a power outlet that is grounded.
- Unplug the power cord when cleaning the machine or not using it.
- Do not operate with wet hands. Prevent water from spilling onto the unit.
- Do not immerse or expose the unit to rain, moisture or any other liquid.
- Do not leave the unit running unattended. Do not tilt or turn over the unit.
- Do not unplug while the unit is operating.
- Do not unplug by pulling on the power cord.
- Do not use an extension cord or an adapter plug.

- Do not put objects on the unit.
- Do not climb or sit on the unit.
- Do not insert fingers or other objects into the air outlet.
- Do not touch the air inlet or the aluminum fins of the unit.
- Do not operate the unit if it is dropped, damaged or showing signs of product malfunction.
- Do not clean the appliance with any chemicals.
- Ensure the unit is far away from fire, inflammable, or explosive objects.
- The unit shall be installed in accordance with national wiring regulations.
- Do not use means to accelerate the defrosting process or cleaning, other than those recommended by the manufacturer.
- The appliance shall be stored in a room without continuous operation sources (for example: open flames, an operating gas appliance or an operating electric heater).
- The appliance shall be stored so as to prevent mechanical damage from occurring.
- Do not burn, even after use.
- Be aware that refrigerants may not contain an odor.
- Compliance with national gas regulations shall be observed.
- Keep any required ventilation openings clear of obstruction.
- The appliance shall be stored in a well-ventilated area where the room size corresponds to the room area as specified for operation.

 Any person who is involved with working on or breaking into a refrigerant circuit should hold a currently valid certificate from an industry-accredited assessment authority, which authorizes their competence to handle refrigerants safely in accordance with industry, recognized assessment specification.

 Servicing shall only be performed as recommended by the equipment manufacturer. Maintenance and repair requiring the assistance of other skilled personnel shall be carried out under the supervision of the person competent in the use of flammable refrigerants.

If you don't understand something or need help, please contact the dealer services.

### 3. PRODUCT OVERVIEW

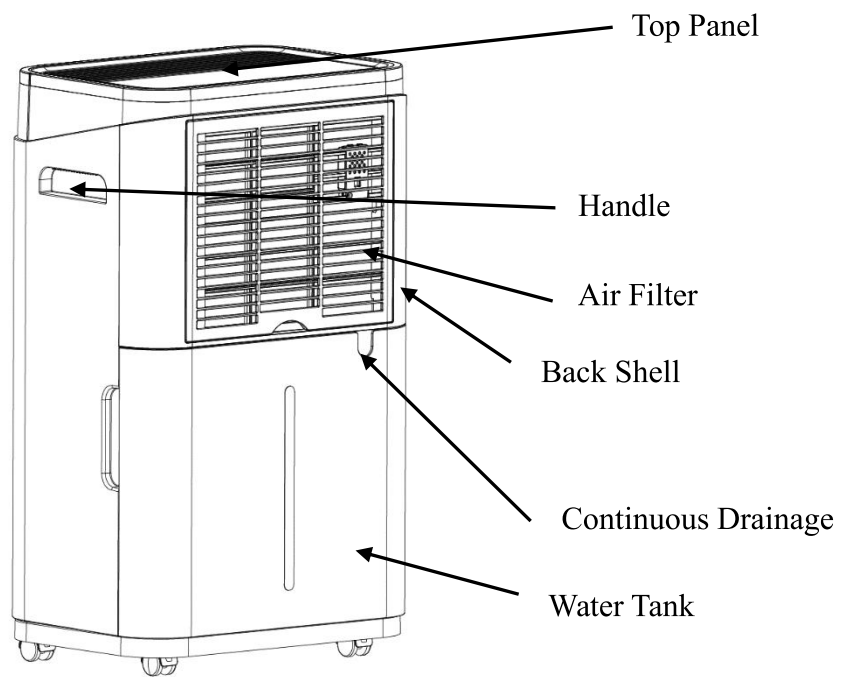
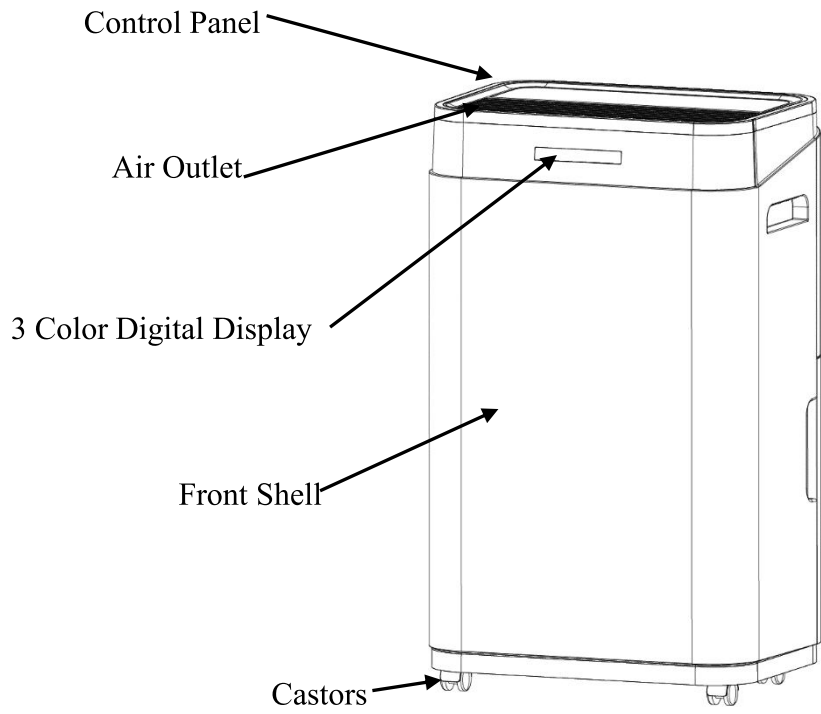

### 3.2 FEATURES

- ✓ Powerful moisture removal
- ✓ Humidity Monitor shows current air humidity
- ✓ Auto mode automatically adjusts humidity levels
- ✓ A 24-hour timer to set the time of operation
- ✓ Effectively removes moisture, dust from the air
- ✓ Low power consumption—Efficient energy
- ✓ Quiet fan with two-speed settings
- ✓ Auto-Defrost at low temperature
- ✓ Auto shut-off/ auto restart
- ✓ Electronic control
- ✓ Laundry drying function
- ✓ Continuous drainage or 6.5L water tank

### 4.PARAMETERS

Model No.	OL20D-D030B
Power Supply	AC115V/60Hz
Rated Input Current	2.7A
Dehumidify Capacity	15Pints/Day@65°F ,60%RH
Dehumidify Capacity	45Pints/Day @86°F ,80%RH
Noise	≤48dB(A)
Full Water Quantity	6.5L
Refrigerant /Charge	R134a/4.59oz
Body Size	13.4 x 9.5x 22.5 in
Net Weight	15.5kg/34 lbs

## 5. INSTALLATION

### 5.1 LOCATION

1. Place the unit on a firm, horizontal surface in an area with at least 30cm of free space around it to allow for proper air circulation.

2. Never install the unit where it could be subject to :

- Heat sources such as radiators, heating registers, stoves or other products that generate heat.
- An area where oil or water can be splashed
- Direct sunlight
- Mechanical vibration or shock
- Excessive dust
- Poor ventilation, e.g. closet or bookcase
- Uneven surface

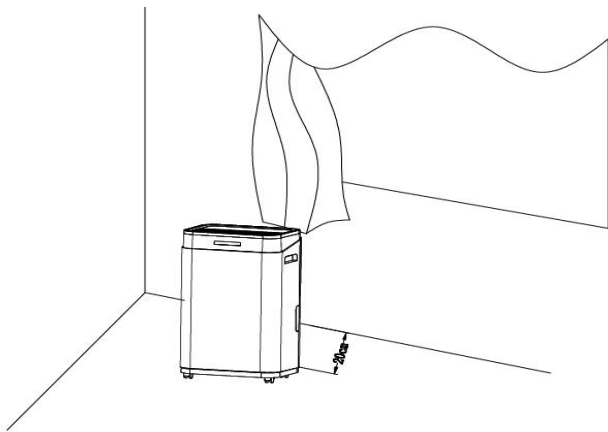

### 5.2 OPERATING THE DEVICE SAFELY

- Check the device after unpacking for any damages or scratches on it.
- Operate this unit in an ambient temperature from 41°F to 100°F.
- Do not use in the outdoors. This dehumidifier is intended for indoor residential applications only.
- Do not operate in close proximity to walls, curtains, or other objects that may block inlet and outlet.
- Keep the air inlet and outlet free of obstacles.
- Adjusting the wind deflector in the upward direction prior to start up.
- If tipped more than 45°, allow the unit to set upright for at least 6 hours before starting up.
- Keep doors and windows close for better energy saving.
- Do not operate or store the unit in direct sunlight or rain.

- It is normal for the air outlet to feel warm to touch after continuous operation on hot days.
- Empty the water tank before moving the device.
- Make sure the water tank is correctly fitted otherwise the unit will not operate properly.
- The dehumidifier starts up in the mode selected when the last the unit was used.
- The dehumidifier starts dehumidifying if the room humidity is 3% higher than the selected humidity.
- There is a protective 3-minutes time delay of the compressor. Wait 3 minutes for the dehumidifier to resume dehumidification.

## 6.OPERATION

### 6.1 DIGITAL DISPLAY

Ambient humidity < 45%, it shows blue.

45% ≤ ambient humidity ≤65%, it turns green.

Ambient humidity > 65%, it displays red.

### 6.2 CONTROL PANEL

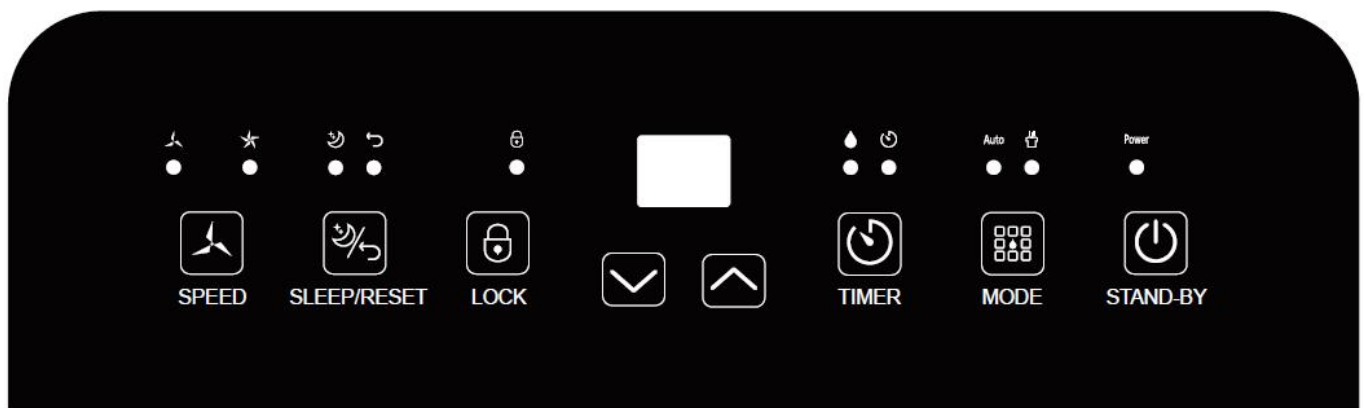



## 6.3 SETTINGS



### Stand By Button

In the standby state, press the power button to turn on, the operation indicator lights up and the default fan speed is high, and the default humidity setting is 50%. In the power-on state, press the power button to turn off, the running indicator light goes off and the compressor stops immediately, and then the fan shuts down after 30 seconds delay.



### Mode Button

Press the mode button to switch between Auto and Continuously dehumidify modes.

Auto mode - Continuously dehumidify mode cycle, press once to switch the mode from one to another, the corresponding indicator will light up.

- **Auto mode:** When environmental humidity  $\geq$  set humidity +3%, the fan starts working and the compressor starts working after 3 seconds. When environmental humidity  $\leq$  set humidity -3%, the compressor stops working and the fan stops working after 30 seconds delay.

Both fan speed and humidity can be adjusted in the auto mode.

- **Continuously dehumidify mode:** In this mode, the machine will continue to run at high fan speed, the default humidity setting is 20%, and both the fan speed and the humidity setting can not be adjusted.



### Sleep/Reset Button

Press the sleep button, the indicator lights up and the sleep mode function activates; touch the button again to close the function.

In sleep mode, the fan speed will be switched to low fan speed automatically, and after no operation for 10 seconds, except sleeping mode indicator light, the power indicator light, water tank full indicator light and child lock indicator light, the other indicator lights and display screen will be off.

When room humidity  $\leq$  57%RH , the compressor will stop working and the fan will stop working 30 seconds later.

When room humidity  $\geq$  63%RH , the fan will start working and compressor will start working 3 seconds later.

The fan speed setting function and humidity setting function is ineffective in this mode, you can

not set humidity value and fan speed.

In sleeping mode, when the water tank is full, the machine will not alarm, but the water tank full indicator light will be on (red color) to remind that the water tank is full and you need to empty the water tank.

Press and hold the sleep mode button for 3s to reset the air filter. When the machine works for 600 hours, the air filter indicator light will be on to remind you to clean the air filter, and the machine will not work until you clean the air filter and press the button to reset the air filter.



### **Timer Button**

Press the timer button to active the timer function and then press the "increase and decrease" button to set the time. Each time you press this button, the value increases by 1 hour, and the value "88" is displayed on the display.

In the running state, use the timer function to "turn off the machine regularly".

In the standby state, use the timer function to "turn on the machine regularly".

Whatever the state is, the timer indicator lights up when the timer is set..

Set the time to "00" to cancel the timing function.



### **Fan Speed Button**

Press this button to switch the fan speed between high and low fan speed cycle, and the corresponding indicator light will be on . The fan speed can be adjusted only in the auto mode.



### **Increase Button**

Press this button to set humidity and timing time;

For humidity adjusting, press one time to add 5% humidity value, the humidity adjusting follows the order as below: 30% - 35% - 40% - 45% - 50% - 55% - 60% - 65% - 70% - 75% - 80% - 30% cycle.

For timing, press one time to add 1 hour timing value, the timing follows the order as below: 00-01-02-03-04-05-06-07-08-09-10-11-12-13-14-15-16-17-18-19-20-21-22-23-24-00 cycle.



### **Decrease Button**

Press this button to set humidity and timing time;

For humidity adjusting, press one time to minus 5% humidity value, the humidity adjusting follows the order as below : 80% - 75% - 70% - 65% - 60% - 55% - 50% - 45% - 40% - 35% - 30% - 80% cycle.

For timing, press one time to minus 1 hour timing value, the timing follows the order as below: 24-23-22-21-20-19-18-17-16-15-14-13-12-11-10-09-08-07-06-05-04-03-02-01-00-24 cycle.



### **Child-lock (Lock)**

When the machine is running, press and hold this button for 3 seconds to open the child-lock function, the indicator light will be on and you can not operate other buttons except this one. Press and hold this button for 3 seconds again to close the child-lock function, the indicator light will be off.

## **6.4 Accessories**

- 1. Water Pipe                    1pcs
- 2. Instruction manual   1pcs

## **6.5 DRAINAGE**

There are two ways of removing collected water produced by the unit.

- A. Manual draining: Empty the water tank manually.
- B. Continuous draining: Use gravity to drain condensate water by attaching a drain hose.

### **6.5.1 EMPTYING THE WATER TANK**

The built-in water tank of the unit will fill up and shut the unit down once it is full. It will run again once you empty the water tank and install it properly.

- 1) When the tank is full, the unit will make a buzzing sound, and the "Water Full" light will turn on.
- 2) Press the POWER button to turn off the unit.
- 3) Pull out the water tank and simply slide out of the body of the dehumidifier.
- 4) Empty the water into an area with a drain or outside.

- 5) Clean the inside of the tank as well as the outside.
- 6) Replace the empty tank back into the unit.
- 7) Press the POWER button to resume operating.
- 8) If the Water Full light does not extinguish, check if the float is correctly in place.

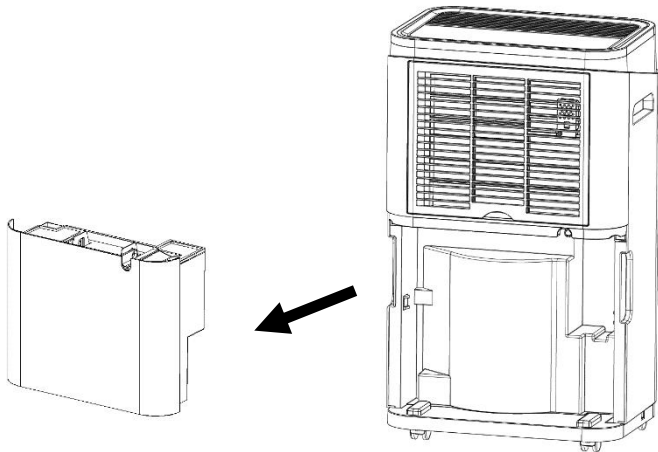

1、 Pull out the water tank

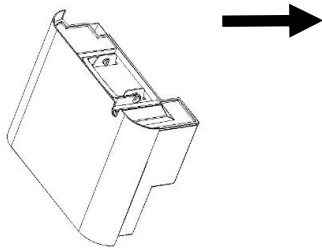

2、 Empty the water tank

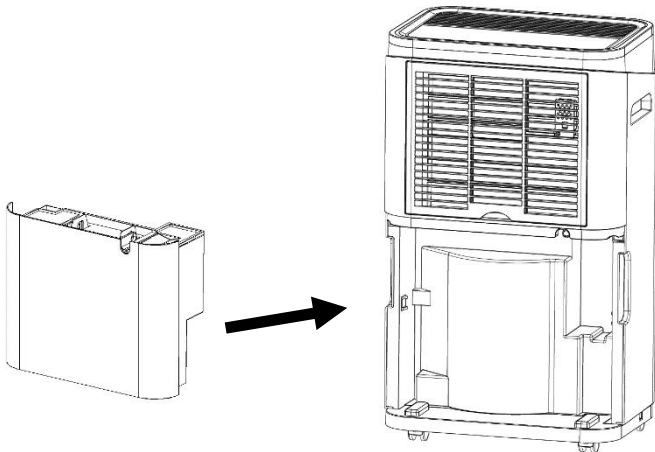

3、 Replace the empty tank back into the unit

**Warning!**

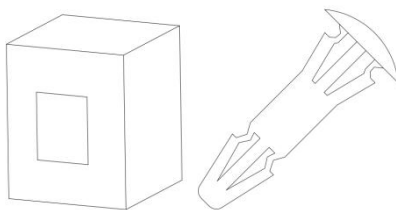

1、 Do not discard the magnets and plastic rivets in the tank. Otherwise, the dehumidifier cannot be started, or the machine will not automatically stop working when the water tank is full, and the condensed water overflow will damage the floor of the room.

- 2、 Please make sure to clean the condensed water in the tank and put the tank in the original position.
- 3、 If the water tank is dirty, please rinse it with clean water. Avoid using detergents, steel wire balls, chemical dust removers, diesel, benzene, thinners or other solvents. Otherwise, it can damage the tank and cause leaks.
- 4、 Put the water tank in its original position. Otherwise, the indicator light will always be red and the machine cannot start working again.

**Continuous drainage:**

- 1、 Take out the PVC pipe, straighten the drain pipe.
- 2、 Insert one end of the drain pipe into the drain outlet at the top of the tank and connect the other end to the bathroom, floor drain, outdoor or bucket-like container, defined drain area.

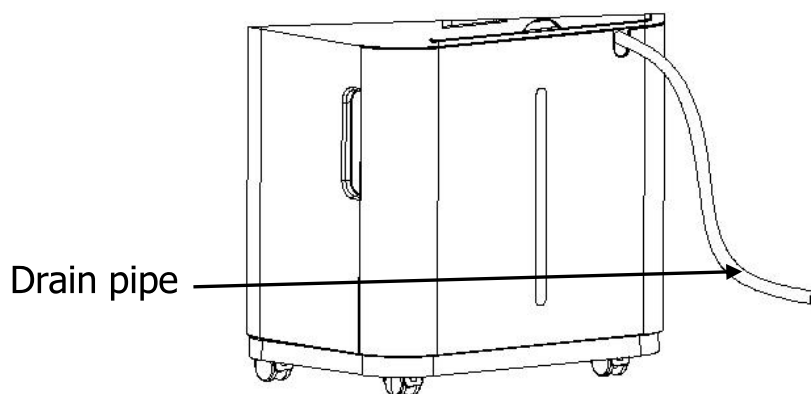

**Warning**

- 1、 Please do not block the drain or drain pipe, if blocking phenomenon, condensed water will flow into the tank.
- 2、 Please do not bend the drain pipe. The height of the drain pipe should be lower than the outlet.
- 3、 The drain pipe must be firmly connected to the outlet.

## 7.MAINTENANCE

Note: Before cleaning and maintaining the machine, please be sure to turn off the machine and unplug the power to avoid electric shock.

CLEANING THE AIR FILTER (every two weeks).

Dust collects on the filter and restricts the airflow. The restricted airflow reduces the efficiency of the system and if it becomes blocked it can cause damage to the unit.

The air filter requires regular cleaning. The air filter is removable for easy cleaning. Do not operate the unit without an air filter, or the evaporator may be contaminated.

Switch off the unit and remove air filter

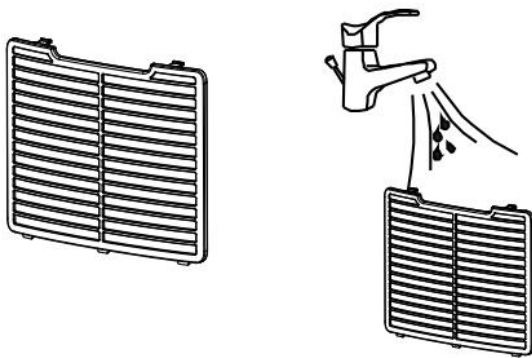
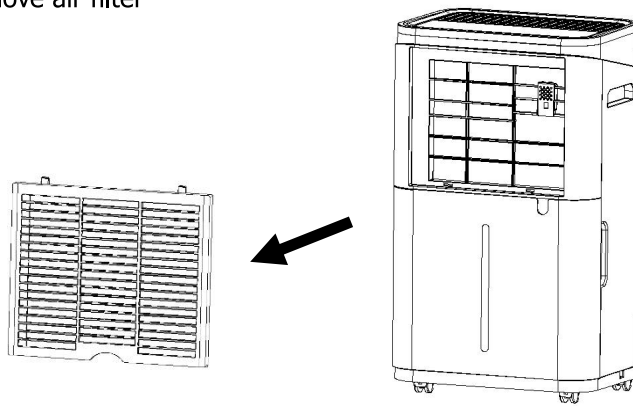

Rinse under a running water or using the vacuum to clean the dust

Reassemble the air filter

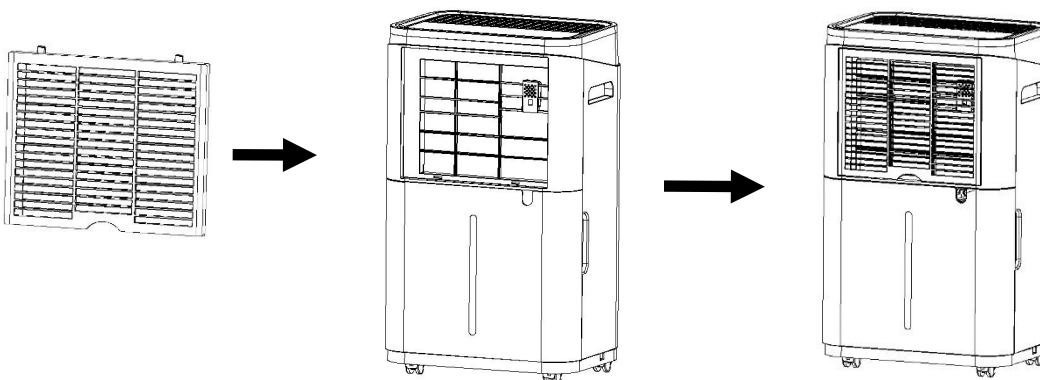

## TROUBLESHOOTING

SYMPTOM	INSPECTION	SOLUTION	
The unit is not operating.	✓ Check the power connection in securely.	➤ Insert the power cord securely into the wall outlet.	
	✓ Check if the water level indicator lights up?	➤ Empty the water tank and reinstall correctly.	
	✓ Check the room temperature.	➤ The range of operating temperature is 41-100°F .	
There is the little formation of condensate.	✓ Check the air filter for dirt.	➤ Clean the air filter as necessary.	
	✓ Check if the air duct is blocked.	➤ To clear the obstacle.	
	✓ Check if the room temperature is below 20°C ( 68°F ) .	➤ This is normal. Low humidity in low temperature environment.	
	✓ Setting humidity level is higher than current humidity value.	➤ Set the humidity level below current humidity value.	
Water Leakage	✓ Overflow while moving the unit.	➤ Empty the water tank before transport.	
	✓ Check if the drain hose is kinked or bends.	➤ Straighten the hose to avoid a trap existing.	
Excessive Noise	✓ Check if the unit is securely positioned.	➤ Place the unit on horizontal and firm ground.	
	✓ Check if any loose, vibrating parts.	➤ Secure and tight the parts.	
	✓ Noise sounds like water flowing.	➤ Noise comes from flowing refrigerant. This is normal.	
Error Code	E2	✓ Humidity sensor dampened or failure.	➤ To clean or replace the humidity sensor.
	CL	✓ Display when Room temperature is below 5°C ( 41°F ) .	➤ Normal. The compressor stops, and the fan keeps running.
	CH	✓ Display when Room temperature is above 38°C ( 100°F ) .	➤ Normal. The compressor stops, and the fan keeps running.
	LO	✓ Display when Room relative humidity is bellow 20%RH.	➤ Normal. The compressor stops, and the fan keeps running.
	HI	✓ Display when Room relative humidity is above 90%RH.	➤ Normal. The compressor stops and the fan keep running.

Thank you for purchasing this product! If you have any questions about the product, such as missing parts, damaged products, product assembling, and operation, please contact us via **Amazon Message** or customer service number: **213-4467172 or 661-4358826**

**IMPORTANT**

Please call our customer service department for any consulting:

**213-4467172**

**661-4358826**

(8:30am - 5:30pm P.S.T.)

DATED PROOF OF PURCHASE IS REQUIRED FOR WARRANTY SERVICE.

**AVIS**

Veillez appeler le service à la clientèle pour toutes questions au:

**213-4467172**

**661-4358826**

(8:30am - 5:30pm P.S.T.)

PREUVE D'ACHAT ORIGINALE REQUISE POUR SERVICE DE GARANTIE.

**IMPORTANTE**

Sólo hay que llamar nuestro departamento de servicio al cliente en caso de tener preguntas o inquietudes:

**213-4467172**

**661-4358826**

(8:30am - 5:30pm P.S.T.)

SE REQUIERE PRUEBA DE COMPRA CON FECHA PARA SERVICIO BAJO GARANTÍA.

**Address : ROWAN ELECTRIC APPLIANCE LLC 28407**

**Ascent Way, Santa Clarita, CA 91350**

**Phone: 213-4467172 or 661-4358826**



